



**Serial Over the NET™  
SN0108 / SN0116  
User Manual**



## FCC, CE Information

**FEDERAL COMMUNICATIONS COMMISSION INTERFERENCE STATEMENT:** This equipment has been tested and found to comply with the limits for a Class A digital device, pursuant to Part 15 of the FCC Rules. These limits are designed to provide reasonable protection against harmful interference when the equipment is operated in a commercial environment. This equipment generates, uses, and can radiate radio frequency energy and, if not installed and used in accordance with the instruction manual, may cause harmful interference to radio communications. Operation of this equipment in a residential area is likely to cause harmful interference in which case the user will be required to correct the interference at his own expense.

**FCC Caution:** Any changes or modifications not expressly approved by the party responsible for compliance could void the user's authority to operate this equipment.

**CE Warning:** This is a class A product. In a domestic environment this product may cause radio interference in which case the user may be required to take adequate measures.

## RoHS

This product is RoHS compliant.

## SJ/T 11364-2006

The following contains information that relates to China.

部件名称	有毒有害物质或元素					
	铅	汞	镉	六价铬	多溴联苯	多溴二苯醚
电器部件	●	○	○	○	○	○
机构部件	○	○	○	○	○	○

- : 表示该有毒有害物质在该部件所有均质材料中的含量均在SJ/T 11363-2006规定的限量要求之下。
- : 表示符合欧盟的豁免条款, 但该有毒有害物质至少在该部件的某一均质材料中的含量超出SJ/T 11363-2006的限量要求。
- ×: 表示该有毒有害物质至少在该部件的某一均质材料中的含量超出SJ/T 11363-2006的限量要求。



## User Information

---

### Online Registration

Be sure to register your product at our online support center:

International	<a href="http://eservice.aten.com">http://eservice.aten.com</a>
---------------	---

### Telephone Support

For telephone support, call this number:

International	886-2-8692-6959
China	86-10-5255-0110
Japan	81-3-5615-5811
Korea	82-2-467-6789
North America	1-888-999-ATEN ext 4988
United Kingdom	44-8-4481-58923

### User Notice

All information, documentation, and specifications contained in this manual are subject to change without prior notification by the manufacturer. The manufacturer makes no representations or warranties, either expressed or implied, with respect to the contents hereof and specifically disclaims any warranties as to merchantability or fitness for any particular purpose. Any of the manufacturer's software described in this manual is sold or licensed *as is*. Should the programs prove defective following their purchase, the buyer (and not the manufacturer, its distributor, or its dealer), assumes the entire cost of all necessary servicing, repair and any incidental or consequential damages resulting from any defect in the software.

The manufacturer of this system is not responsible for any radio and/or TV interference caused by unauthorized modifications to this device. It is the responsibility of the user to correct such interference.

The manufacturer is not responsible for any damage incurred in the operation of this system if the correct operational voltage setting was not selected prior to operation. PLEASE VERIFY THAT THE VOLTAGE SETTING IS CORRECT BEFORE USE.

## Package Contents

---

The SN0108 / SN0116 package consists of:

- ◆ 1SN0108, SN0116, SN0108D, or SN0116D
- ◆ 1Power Cord (SN0108 or SN0116)
- ◆ 1Rack Mount Kit (Brackets and Phillips head hex M3 x 8 screws)
- ◆ 1Foot Pad Set (4 pcs.)
- ◆ 1Software CD
- ◆ 1User Manual\*
- ◆ 1Quick Start Guide

Check to make sure that all of the components are present and in good order. If anything is missing, or was damaged in shipping, contact your dealer.

Read this manual thoroughly and follow the installation and operation procedures carefully to prevent any damage to the switch or to any other devices on the installation.

---

\* Features may have been added to the manual since it was published. Please visit our website to download the most up to date version.

---

Copyright © 2004-2014 ATEN® International Co., Ltd.  
Manual Part No. PAPE-0241-3AXG  
Printing Date: 5/2014

ATEN and the ATEN logo are registered trademarks of ATEN International Co., Ltd. All rights reserved.  
All other brand names and trademarks are the registered property of their respective owners.

# Contents

---

FCC, CE Information . . . . .	ii
SJ/T 11364-2006 . . . . .	ii
User Information . . . . .	iii
Online Registration . . . . .	iii
Telephone Support . . . . .	iii
User Notice . . . . .	iii
Package Contents . . . . .	iv
About This Manual . . . . .	ix
Overview . . . . .	ix
Conventions . . . . .	x
Product Information . . . . .	x
<b>Chapter 1.</b>	
<b>Introduction</b>	
Overview . . . . .	1
Requirements . . . . .	2
Features . . . . .	3
Components . . . . .	5
SN0108 / SN0108D Front Panel . . . . .	5
SN0116 / SN0116D Front Panel . . . . .	5
SN0108 / SN0116 Rear Panel (AC Power) . . . . .	6
SN0108D / SN0116D Rear Panel (DC Power) . . . . .	7
<b>Chapter 2.</b>	
<b>Hardware Setup</b>	
Before you Begin . . . . .	9
Stacking and Mounting . . . . .	9
Stacking . . . . .	9
Rack Mounting . . . . .	10
SN0108 / SN0116 PC Installation . . . . .	11
SN0108D / SN0116D PC Installation . . . . .	13
SN0108 / SN0116 Sun Fire V100 Server Installation . . . . .	15
SN0108D / SN0116D Sun Fire V100 Server Installation . . . . .	17
<b>Chapter 3.</b>	
<b>Browser Login</b>	
Logging In . . . . .	19
The SN0108 / SN0116 Main Screen . . . . .	20
Logging Out . . . . .	20
<b>Chapter 4.</b>	
<b>Administration</b>	
Working Environment Configuration . . . . .	21

General	21
System Information	22
Administrator	22
Connection Control	22
Network	23
Service Ports	23
IP Installer	23
IP Address	24
ANMS	25
CC Management Settings:	25
RADIUS Settings:	26
SNMP Settings:	27
OOBC	28
Date / Time	29
Firmware	30
Firmware Upgrade	30
Private Certificate	31
Generating a Self-Signed Certificate	31
Obtaining a CA Signed SSL Server Certificate	31
Importing the Private Certificate	31
Device Management Configuration	32
Port Config	32
Property Settings	33
Alert Settings:	36
User Manager	37
Deleting an Account	38
Adding an Account:	38
Editing an Account:	39
Direct Access	40
Session Info	41
Sys Info	42
Log	43

## **Chapter 5.**

### **Browser Operation**

Overview	45
Telnet	47
Port Configuration	51
User Manager	51

## **Chapter 6.**

### **Out of Band Operation**

Overview	53
HyperTerminal	53
Direct HyperTerminal Connection	53
Setup:	53

Logging In: . . . . .	57
Indirect HyperTerminal Connection . . . . .	58
Setup: . . . . .	58
Final Check: . . . . .	59
Logging In . . . . .	60
PPP (Dial In) Connection . . . . .	61
Direct PPP Connection . . . . .	61
Setup: . . . . .	61
Finishing Up: . . . . .	64
Logging In: . . . . .	64
Indirect PPP Connection . . . . .	65
Setup: . . . . .	65
Final Check: . . . . .	66
Logging In: . . . . .	66
Telnet . . . . .	67
Logging In . . . . .	67
SSH . . . . .	68
Terminal Session (Linux): . . . . .	68
Third Party Utility (Windows): . . . . .	69

## **Chapter 7.**

### **Real COM Port Management**

Overview . . . . .	71
Driver Installation . . . . .	71
Windows 2000 and Higher Installation . . . . .	71
Uninstalling the Driver . . . . .	72
Windows 98 Installation . . . . .	72
Uninstalling the Driver . . . . .	72
Linux Installation . . . . .	73
Preparation . . . . .	73
Installing the Driver . . . . .	73
Uninstalling the Driver . . . . .	73
Real COM Port Management – Windows . . . . .	74
Dialog Box Layout . . . . .	74
Menu and Toolbar . . . . .	75
Target Information . . . . .	75
Target List . . . . .	76
Port List . . . . .	77
Mapped COM Ports . . . . .	78
Port Mapping and Unmapping . . . . .	78
Port Mapping . . . . .	78
Port Unmapping . . . . .	79
Real COM Port Management – Linux . . . . .	80
Mapping/Unmapping Virtual Ports . . . . .	80
Virtual Port Naming Rules . . . . .	80

**Appendix**

Safety Instructions . . . . .	81
General . . . . .	81
DC Power . . . . .	83
Rack Mounting . . . . .	84
Consignes de sécurité . . . . .	85
Général . . . . .	85
Montage sur bâti . . . . .	88
Technical Support . . . . .	89
International . . . . .	89
North America . . . . .	89
Specifications . . . . .	90
SN0108 / SN0116 . . . . .	90
SN0108D / SN0116D . . . . .	91
Administrator Login Failure . . . . .	92
IP Address Determination . . . . .	93
Method 1: . . . . .	93
Method 2: . . . . .	94
Method 3: . . . . .	94
Self-Signed Private Certificates . . . . .	95
Examples . . . . .	95
Importing the Files . . . . .	95
RJ-45 to Serial Adapters . . . . .	96
Troubleshooting . . . . .	100
Battery Replacement . . . . .	100
Limited Warranty . . . . .	101



## About This Manual

---

This User Manual is provided to help you get the most from your SN0108 / SN0116 system. It covers all aspects of installation, configuration and operation. An overview of the information found in the manual is provided below.

### Overview

**Chapter 1, Introduction,** introduces you to the SN0108 / SN0116 System. Its purpose, features and benefits are presented, and its front and back panel components are described.

**Chapter 2, Hardware Setup,** provides step-by-step instructions for setting up your installation.

**Chapter 3, Browser Login,** explains how to log into the SN0108 / SN0116 from your browser.

**Chapter 4, Administration,** explains the administrative procedures that are employed to configure the SN0108 / SN0116's working environment.

**Chapter 5, Browser Operation,** details concepts and procedures involved in the browser operation of your SN0108 / SN0116 installation.

**Chapter 6, Out of Band Operation,** describes how to set up the various serial port methods that can be used to access the SN0108 / SN0116 when the network is unavailable.

**Chapter 7, Real COM Port Management,** shows how to install the virtual COM port driver and to set up and manage the virtual COM ports.

**An Appendix,** at the end of the manual provides technical and troubleshooting information.

## **Conventions**

This manual uses the following conventions:

- Monospaced      Indicates text that you should key in.
- [ ]      Indicates keys you should press. For example, [Enter] means to press the **Enter** key. If keys need to be chorded, they appear together in the same bracket with a plus sign between them: [Ctrl+Alt].
1.      Numbered lists represent procedures with sequential steps.
- ◆      Bullet lists provide information, but do not involve sequential steps.
- Indicates selecting the option (on a menu or dialog box, for example), that comes next. For example, Start → Run means to open the *Start* menu, and then select *Run*.
-       Indicates critical information.

## **Product Information**

---

For information about all ALTUSEN products and how they can help you connect without limits, visit ALTUSEN on the Web or contact an ALTUSEN Authorized Reseller. Visit ALTUSEN on the Web for a list of locations and telephone numbers:

International	<a href="http://www.aten.com">http://www.aten.com</a>
North America	<a href="http://www.aten-usa.com">http://www.aten-usa.com</a>

# Chapter 1

## Introduction

### Overview

---

The SN0108 / SN0116 Serial over the NET™ series are control units that provide both In-Band and Out-of-Band remote serial access to up to 8 (SN0108) or 16 (SN0116) servers or other serial IT devices (hubs, routers, power management devices, etc.), via a Telnet or SSH TCP/IP connection.

Up to 8 (SN0108) or 16 (SN0116) Users can log in at the same time from any computer connected to the Internet, whether down the hall, or half way around the world. Each is able to control a separate port so that eight attached devices can be accessed at the same time.

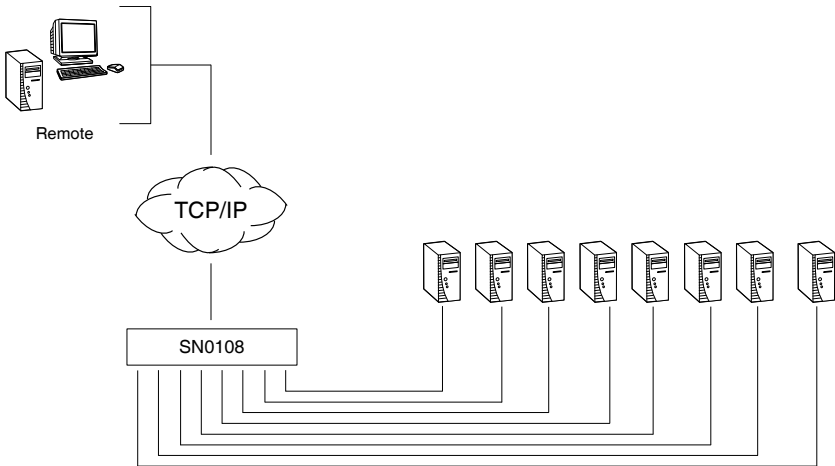

There are four models in the series. Their similarities and differences are shown in the following table:

Model	KVM Ports	Power
SN0108	8	AC
SN0116	16	AC
SN0108D	8	DC
SN0116D	16	DC

The SN0108 / SN0116 can work in tandem with other remote management products - such as the Altusen PN9108 Power over the NET™ remote power management system to provide convenient, reliable, and effective, remote data center device management.

Installation is fast and easy: plugging cables into their appropriate ports is all that is entailed. A choice of browser based GUI, Telnet (SSH), and VT console terminal sessions make configuration and operation smooth and convenient.

The SN0108 / SN0116's firmware is upgradeable over the Net, so you can stay current with the latest improvements simply by downloading updates from our website. With its advanced features and ease of operation, the SN0108 / SN0116 is the most convenient, most reliable, and most cost effective way to centrally manage your remote, serially connected, IT products.

## Requirements

---

- ◆ Sun's Java 2 JRE 1.4.2 or higher must be installed on your computer. Java is available for free download from the Sun Java website:

<http://java.sun.com>

- ◆ The devices that connect to the SN0108 / SN0116 must support the RS-232 protocol or RS-232 terminal operations
- ◆ Virtual COM port driver (Real COM port) support requires Windows 98 or higher (Windows systems); or Linux kernel 2.2 or higher (Linux systems).

## Features

---

### ■ Complete Centralized Remote Serial Management:

- ◆ Remote serial access over the Internet for up to 8 (SN0108) or 16 (SN0116) servers or other serial IT devices
- ◆ Works in tandem with other Altusen/Aten appliances - such as the PN0108 and PN9108 - allowing administrators to manage a wide range of data center devices through IP connections
- ◆ Remote access to Serial over IP appliances, and attached devices, in centralized manner
- ◆ Session history
- ◆ DC Operation (SN0108D - SN0116D)

### ■ Security:

- ◆ Multi level secure user logins
- ◆ Port-specific access rights
- ◆ Supports Active Directory (via CC management)
- ◆ Supports RADIUS

### ■ Convenient Access:

- ◆ Browser access with an intuitive GUI – Java applet provides SSH connectivity with cut and paste and print screen capability
- ◆ Telnet client plus third party (PuTTY, etc.) client support – SSH connectivity available via PuTTY
- ◆ Console terminal
- ◆ Direct port addressing - via SSH to any Serial Over IP port (bypassing the SN0108 / SN0116)
- ◆ Dial in Modem and Direct Access via serial applications (such as HyperTerminal and PPP), or IP applications (such as SSH and Telnet)
- ◆ Modem sharing capability via IP-forwarding [Modem support]

### ■ Sun Ready:

- ◆ Hardware break suppression ensures uninterrupted Solaris server operation

### ■ Network Interfaces:

- ◆ TCP/IP, UDP/IP, HTTP, HTTPS, NTP, SNMP, Telnet, SSH, SSL, PPP
- ◆ 10Base-T/100BaseTX, auto sense
- ◆ DNS, DHCP, ARP, RADIUS
- ◆ Ping

■ **Serial Connectivity:**

- ◆ VT320 support – backward compatible to VT52 (VT52, 100, 220)
- ◆ Hardware and software flow control
- ◆ Real COM port support\*
- ◆ Raw TCP Mode support with file-based sessions

■ **Alarms and Alerts:**

- ◆ Client applications
- ◆ Buzzer
- ◆ SNMP Traps

■ **OS Support:**

- ◆ Windows
- ◆ Mac
- ◆ Sun
- ◆ Linux
- ◆ Unix
- ◆ AIX
- ◆ DOS 6.2+

■ **Code Set Support:**

- ◆ ISO646 - US (US ASCII)
- ◆ ISO8859 - 15 (Latin -9)

■ **General:**

- ◆ Hot-pluggable - add and remove servers without rebooting
- ◆ Rack mountable in 1U system rack
- ◆ Easy setup – plugging cables into their ports is all it takes

---

\* With supplied Virtual COM port driver.

---

## Components

### SN0108 / SN0108D Front Panel

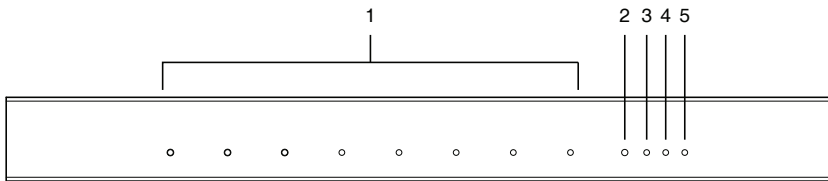

### SN0116 / SN0116D Front Panel

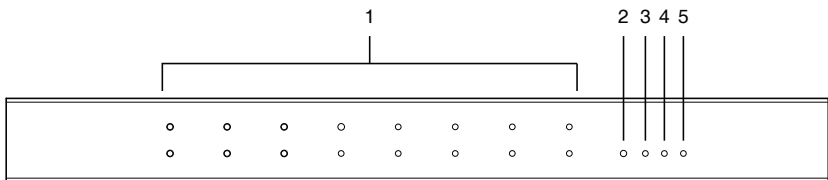

No.	Component	Description
1	Port LEDs	A Port LED lights to indicate the device attached to its corresponding port is online. The LED flashes when data is being transmitted through its corresponding port.
2	Reset Switch	Pressing and holding this switch in for less than three seconds performs a system reset. Pressing and holding this switch in for more than three seconds returns its settings to their default status.
3	10/100 Mbps Data LED	The LED lights ORANGE to indicate a 10 Mbps data transmission speed. It lights GREEN to indicate a 100 Mbps data transmission speed.
4	Link LED	Flashes GREEN to indicate that a Client program is accessing the device.
5	Power LED	Lights when the SN0108 is powered up and ready to operate.

## SN0108 / SN0116 Rear Panel (AC Power)

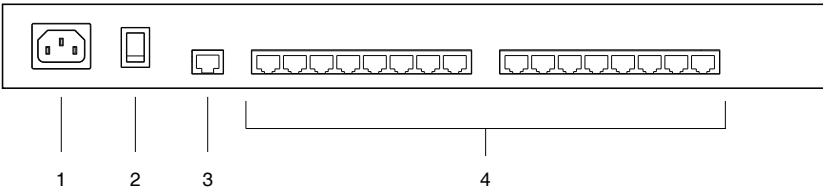
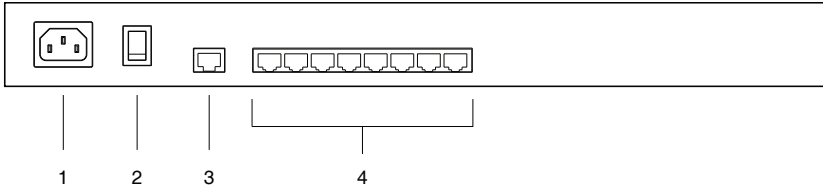

No.	Component	Description
1	Power Socket	The power cable from your AC source plugs in here.
2	Power Switch	This is a standard rocker switch that powers the SN0108 / SN0116 on and off.
3	LAN Port	The Ethernet cable that connects the SN0108 / SN0116 to the Internet plugs in here.
4	Serial Ports	The Cat 5 cables that connect to the RJ45 to Serial adapters plug in here. (See <i>SN0108D / SN0116D PC Installation Diagram</i> ., page 14, and <i>RJ-45 to Serial Adapters</i> , page 96.) <b>Note:</b> RJ-45 to Serial adapters require a separate purchase. To purchase RJ-45 to Serial adapters, contact your dealer.



## SN0108D / SN0116D Rear Panel (DC Power)

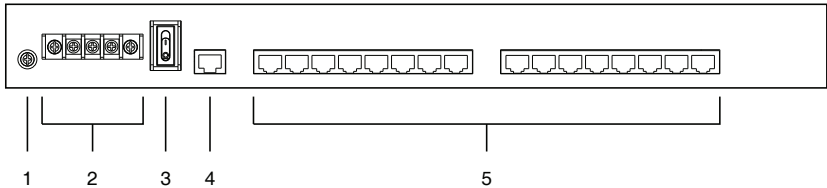
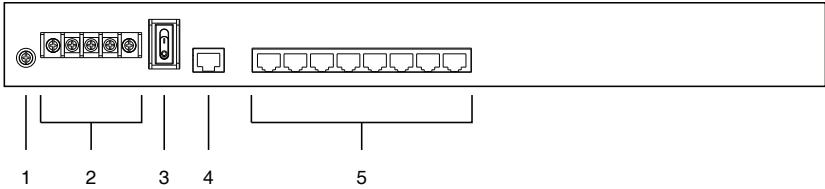

No.	Component	Description
1	Grounding Terminal	Attach the wire to ground this device here.
2	DC Terminal Block	The electric leads from your power source connect to this DC terminal block.
3	Power Switch	This is a standard rocker switch that powers the SN0108D / SN0116D on and off.
4	LAN Port	The Ethernet cable that connects the SN0108D / SN0116D to the Internet plugs in here.
5	Serial Ports	The Cat 5 cables that connect to the RJ45 to Serial adapters plug in here. (See <i>SN0108D / SN0116D PC Installation Diagram</i> ., page 14, and <i>RJ-45 to Serial Adapters</i> , page 96.) <b>Note:</b> RJ-45 to Serial adapters require a separate purchase. To purchase RJ-45 to Serial adapters, contact your dealer.

This Page Intentionally Left Blank

# Chapter 2

## Hardware Setup

### Before you Begin

---



1. Important safety information regarding the placement of this device is provided onpage 81. Please review it before proceeding.
2. Make sure that power to all the devices you will be connecting up have been turned off.

### Stacking and Mounting

---

The SN0108 / SN0116 can be placed on the desktop or it can be rack mounted, as described in the sections that follow.

#### Stacking

To place the SN0108 / SN0116 on the desktop stick the self-adhesive footpads that came with your package to the unit's bottom panel at the four corners.

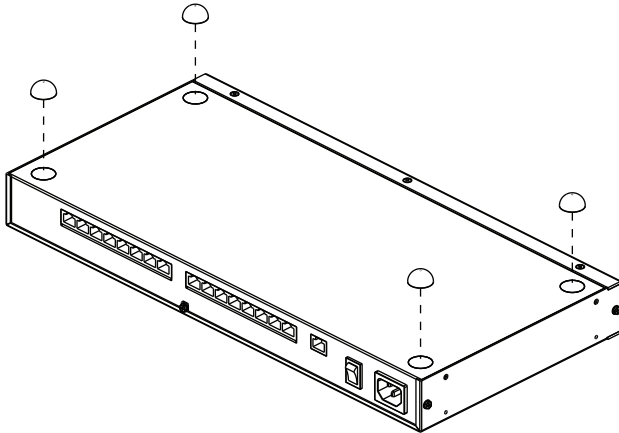

## **Rack Mounting**

The SN0108 / SN0116 can be mounted in a 1U system rack. The mounting brackets can screw into either the front or the back of the unit so that it can attach to the front or the back of the rack. To rack mount the unit:

1. Remove the screws at the front or the rear, as shown in the diagram below.

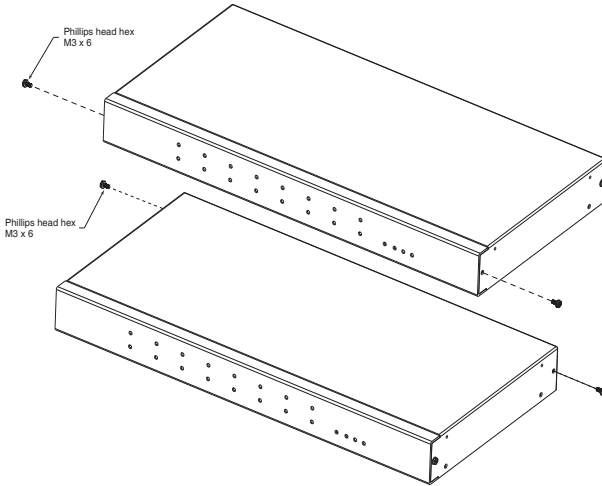

2. Screw the mounting brackets into the sides of the unit at the front or the rear, as shown in the diagram below.

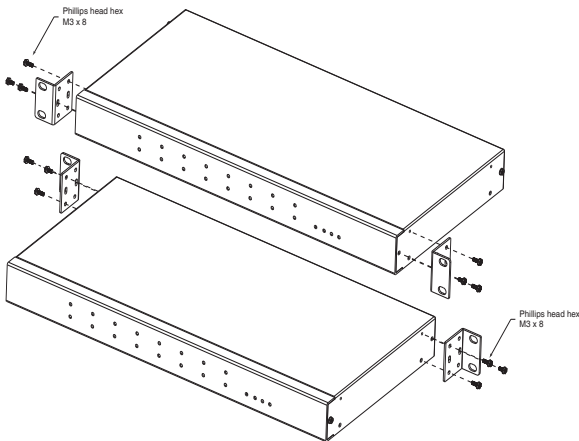

3. Slide the unit into the front or rear of the rack and secure it to the rack.

---

## SN0108 / SN0116 PC Installation

---

Refer to the Installation Diagram on page 12 (the numbers in the diagram correspond to the numbers of the steps), as you do the following:

1. For each server or serial device, plug an *RJ45 to Serial* adapter into its serial port. (See *RJ-45 to Serial Adapters*, page 96, for details on choosing the appropriate adapter.)

---

**Note:** RJ-45 to Serial adapters require a separate purchase. To purchase RJ-45 to Serial adapters, contact your dealer.

---

2. Use standard Ethernet cable to connect any available port on the SN0108 / SN0116's rear panel to the adapter.
3. If you choose to install a serial modem for OOB operation (see Chapter 6), use standard Ethernet cable to connect any available port on the SN0108 / SN0116's rear panel to a DTE to DCE serial adapter (see *RJ-45 to Serial Adapters*, page 96 for details on choosing the appropriate adapter), then plug the adapter into the modem's serial port.

---

**Note:** This step is optional.

---

4. Plug the cable that connects the SN0108 / SN0116 to the network or the Internet into its LAN port.
5. Use the AC power cord provided with this package to connect the SN0108 / SN0116's Power Socket to an AC power source.

This completes the SN0108 / SN0116 installation.

### SN0108 / SN0116 PC Installation Diagram:

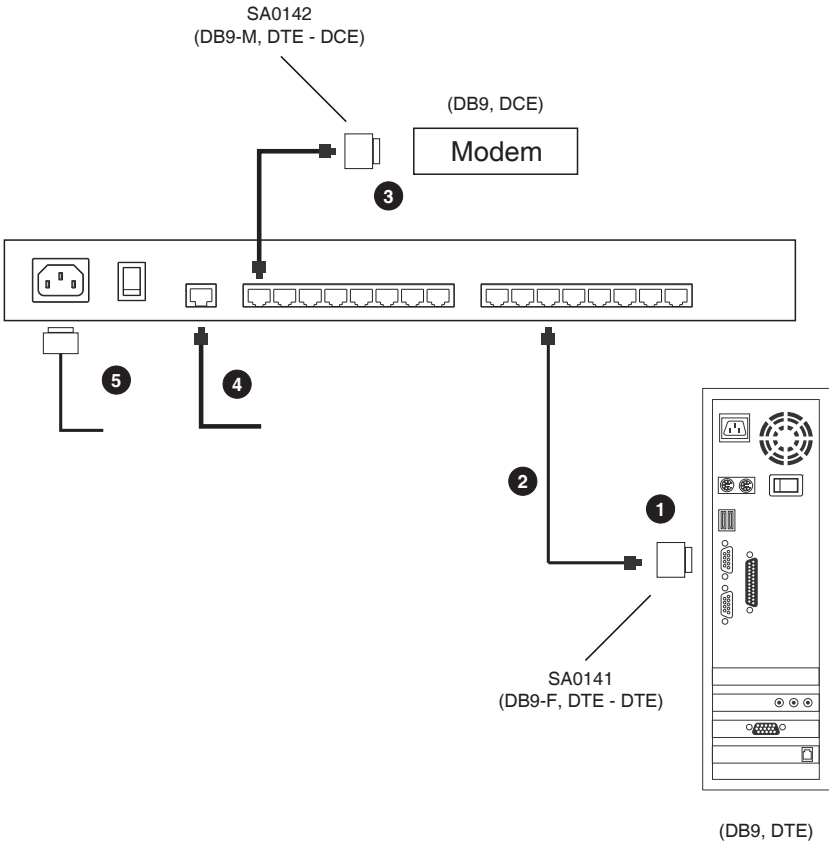

---

## SN0108D / SN0116D PC Installation

---

Refer to the Installation Diagram on page 14 (the numbers in the diagram correspond to the numbers of the steps), as you do the following:

1. For each server or serial device, plug an *RJ45 to Serial* adapter into its serial port. (See *RJ-45 to Serial Adapters*, page 96, for details on choosing the appropriate adapter.)

---

**Note:** RJ-45 to Serial adapters require a separate purchase. To purchase RJ-45 to Serial adapters, contact your dealer.

---

2. Use standard Ethernet cable to connect any available port on the SN0108D / SN0116D's rear panel to the adapter.
3. If you choose to install a serial modem for OOB operation (see Chapter 6), use standard Ethernet cable to connect any available port on the SN0108D / SN0116D's rear panel to a DTE to DCE serial adapter (see *RJ-45 to Serial Adapters*, page 96 for details on choosing the appropriate adapter), then plug the adapter into the modem's serial port.

---

**Note:** This step is optional.

---

4. Plug the cable that connects the SN0108D / SN0116D to the network or the Internet into its LAN port.
5. Connect the DC power source to the switch (refer to the installation diagram for details).
6. Ground the switch.

This completes the SN0108D / SN0116D installation.

### SN0108D / SN0116D PC Installation Diagram:

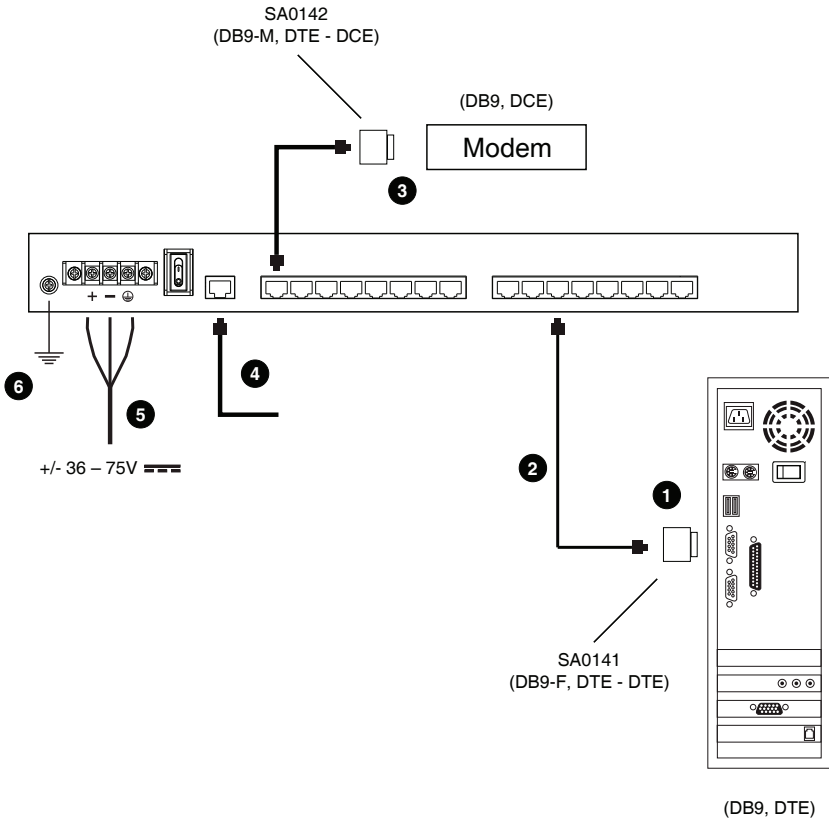



## **SN0108 / SN0116 Sun Fire V100 Server Installation**

---

For each Sun Fire V100 server you wish to install, refer to the Installation Diagram on page 16 (the numbers in the diagram correspond to the numbers of the steps), as you do the following:

1. Use standard Ethernet cable to connect any available port on the SN0108 / SN0116's rear panel to an SA0141 adapter.
2. Use standard Ethernet cable to connect the V100's LAN port to an SA0142 adapter.
3. Connect the two adapters.

---

**Note:** If you choose to install a serial modem for OOB operation (see Chapter 6), refer to step 3 of the PC installation procedure (see page 11).

---

4. Plug the cable that connects the SN0108 / SN0116 to the network or the Internet into its LAN port.
5. Use the AC power cord provided with this package to connect the SN0108 / SN0116's Power Socket to an AC power source.

This completes the SN0108 / SN0116 installation.

## SN0108 / SN0116 Sun Fire V100 Server Installation Diagram

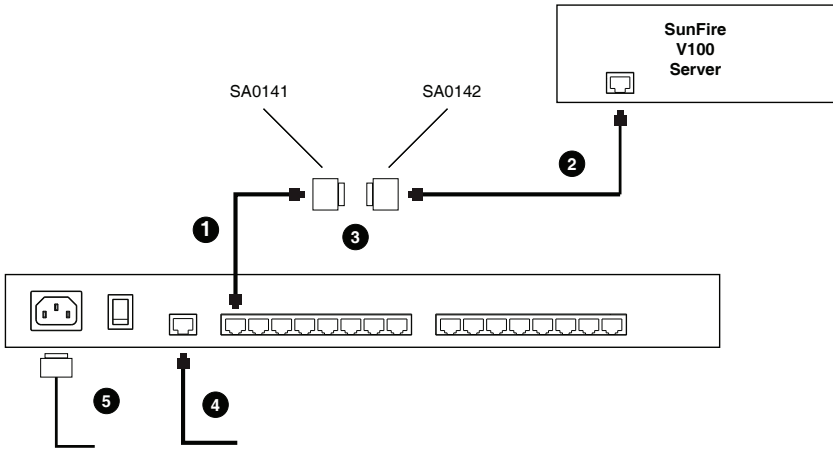

## **SN0108D / SN0116D Sun Fire V100 Server Installation**

---

For each Sun Fire V100 server you wish to install, refer to the Installation Diagram on page 18 (the numbers in the diagram correspond to the numbers of the steps), as you do the following:

1. Use standard Ethernet cable to connect any available port on the SN0108D / SN0116D's rear panel to an SA0141 adapter.
2. Use standard Ethernet cable to connect the V100's LAN port to an SA0142 adapter.
3. Connect the two adapters.

---

**Note:** If you choose to install a serial modem for OOB operation (see Chapter 6), refer to step 3 of the PC installation procedure (see page 13).

---

4. Plug the cable that connects the SN0108D / SN0116D to the network or the Internet into its LAN port.
5. Connect the DC power source to the switch (refer to the installation diagram for details).
6. Ground the switch.

This completes the SN0108D / SN0116D installation.

## SN0108D / SN0116DSun Fire V100 Server Installation Diagram

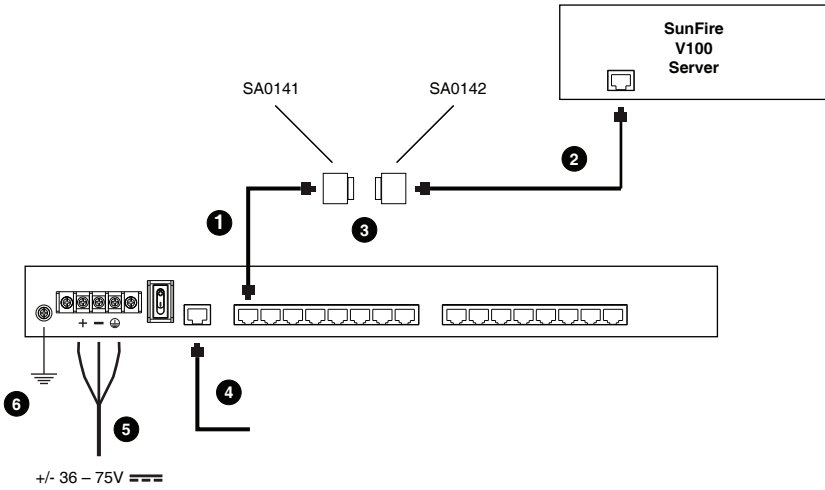

# Chapter 3

## Browser Login

### Logging In

---

SN0108 / SN0116 operation is Internet browser based. To begin:

1. Open your browser and specify the IP address of the SN0108 / SN0116 you want to access in the browser's URL location bar.

---

**Note:** 1. Get the IP address from the SN0108 / SN0116 administrator.

2. If you are the administrator, and are logging in for the first time, the various ways to determine the SN0108 / SN0116's IP address are described in the Appendix on p. 93.

---

2. A *Security Alert* dialog box appears. Accept the certificate.
3. A login dialog box, like the one below, appears:

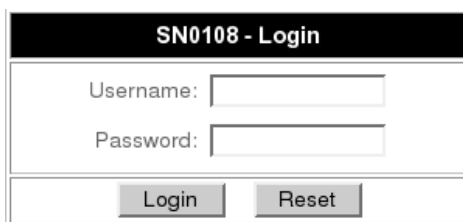

The image shows a login dialog box titled "SN0108 - Login". It has a black header bar with the title in white. Below the header, there are two input fields: "Username:" followed by a text box, and "Password:" followed by a text box. At the bottom of the dialog, there are two buttons: "Login" and "Reset".

4. Provide a valid Username and Password (set up by the administrator), then Click **Login** to continue.

---

**Note:** If you are the administrator, and are logging in for the first time, use the default Username: *administrator*; and the default Password: *password*. For security purposes, we strongly recommend you remove these and give yourself a unique Username and Password (see *General*, page 21).

---

## The SN0108 / SN0116 Main Screen

After you have successfully logged in, the Main Screen appears:

Serial Port Status							
Port Number	Port Name	Status	TCP Port	Tx Bytes	Rx Bytes	Online	
COM1	Console	-	5001	16	0	Off	
COM2	COM2	-	5002	0	0	Off	
COM3	COM3	-	5003	0	0	Off	
COM4	COM4	-	5004	2513	7200	Off	
COM5	COM5	-	5005	0	0	Off	
COM6	COM6	-	5006	0	0	Off	
COM7	COM7	-	5007	0	0	Off	
COM8	COM8	-	5008	0	0	Off	
COM9	COM9	-	5009	0	0	Off	
COM10	COM10	-	5010	0	0	Off	
COM11	COM11	-	5011	0	0	Off	
COM12	COM12	-	5012	0	0	Off	
COM13	COM13	-	5013	0	0	Off	
COM14	COM14	-	5014	0	0	Off	
COM15	COM15	-	5015	0	0	Off	
COM16	COM16	-	5016	0	0	Off	

- ◆ Except for the *Logout* icon, the icons arranged horizontally across the top are only enabled for the administrator. Administrative functions are explained in Chapter 4.

---

**Note:** Be sure to click the *Logout* icon when you end your session.

---

- ◆ The bar along the left side is used to configure and control access to each of the SN0108 / SN0116's COM ports. The functions of each of the buttons is described in Chapter 5.
- ◆ Unless you need to perform administrative functions, you can skip to Chapter 5 now.

## Logging Out

Click the *Logout* icon to end your SN0108 / SN0116 session.

# Chapter 4 Administration

## Working Environment Configuration

---

The icon bar across the top of the SN0108 / SN0116 web page is used by the administrator to configure its working environment.



An explanation of the functions is given in the sections that follow.

---

**Note:** The icons at the top of the page are disabled for all but the administrator. Only *Logout* is active for everyone else.

---



### General

When you click the *General* icon, the following dialog box appears:

### General Settings

**System Information**

Station Name:

Station Description:

---

**Administrator**

Name:

Old Password:

Password:

Confirm Password:

Comments:

---

**Connection Control**

Session timeout:  min. (0: Disable)

The dialog box is divided into three main panels:

### **System Information**

The System Information section allows you to provide a name and description for the SN0108 / SN0116 Station. Providing a *Station Name* and *Station Description* is optional, but makes it convenient to differentiate the Stations in large, multistation installations.

### **Administrator**

This section sets the administrator's login name and password.

- ◆ The default administrator name is: *administrator*
- ◆ The default password is: *password*

For security purposes, we strongly recommend that you change the default values to something unique.

The *Comments* field is optional. It provides administrators with a place to enter personal comments.

### **Connection Control**

*Session Timeout* sets a timeout value. If there is no input from the logged in operator for the amount of time set with this function, the operator is automatically logged out and the session is terminated. Valid settings are from 0 ~ 255 minutes. A setting of 0 (zero) disables this function. The default is 3 minutes.





## Network

Network Configuration allows you to set up the network parameters for the SN0108 / SN0116:

Network Configuration	
Service Ports:	HTTP: <input type="text" value="80"/>
	HTTPS: <input type="text" value="443"/>
	Telnet: <input type="text" value="23"/>
	SSH: <input type="text" value="22"/>
	Socket: <input type="text" value="5001"/> Base socket for COMs
IP Installer Setting:	<input checked="" type="radio"/> Enabled <input type="radio"/> View Only <input type="radio"/> Disabled
<input type="checkbox"/> Obtain an IP address automatically [DHCP]	
Primary IP:	<input type="text" value="10.0.100.108"/>
Primary Subnet Mask:	<input type="text" value="255.255.255.0"/>
Gateway:	<input type="text" value="10.0.100.1"/>
Primary DNS Server:	<input type="text"/>
Alternate DNS Server:	<input type="text"/>
<input type="checkbox"/> Enable report from the following SMTP Server	
SMTP Server:	<input type="text"/>
<input type="checkbox"/> My server requires authentication	
Account Name:	<input type="text"/>
Password:	<input type="text"/>
From:	<input type="text"/>
To:	<input type="text"/>
<input type="button" value="Update"/>	

### Service Ports

Lets you select the service ports that the SN0108 / SN0116 listens for incoming data on. Unless you have a specific reason for changing them, we recommend you leave the default settings as they are.

### IP Installer

Click a radio button to *Enable/Disable* the IP Installer utility (see *Method 1:*, page 93, for IP Installer details).

---

**Note:** If you choose *View Only*, the utility will be enabled as far as showing the SN0108 / SN0116 in the Device List, but you will not be able to use it to assign IP addresses.

---

## IP Address

The SN0108 / SN0116's default setting is to obtain its IP address automatically from a DHCP server. (There is a check in the *Obtain an IP address automatically [DHCP]* checkbox.) When the SN0108 / SN0116 starts, it waits to get an address from a DHCP server. If, after one minute, it fails to obtain an address from the DHCP server, it reverts to its default IP address of 192.168.0.60.

To give the SN0108 / SN0116 a fixed IP address, uncheck the *Obtain an IP address automatically [DHCP]* checkbox, and fill in the *Primary IP* to *Alternate DNS Server* fields with values appropriate to the network you are on.

To have your SMTP server email the DHCP-generated IP address to you, do the following:

1. Enable the *Enable report from the following SMTP server* checkbox, and key in the IP address of your SMTP server.
2. If your server requires authentication, put a check in the *My server requires authentication* checkbox.
3. Key in the appropriate account information in the *Account Name*, *Password*, and *From* fields.
4. Key in the email address of where you want the report of the DHCP address sent to in the *To* field.
5. When all of your configuration settings have been made, click **Update** to save the information and have the SN0108 / SN0116's DHCP generated IP address emailed to you.

---

**Note:** If the SN0108 / SN0116 is on a network that uses DHCP to assign network addresses, and you don't know what the address is, there are several methods you can use to ascertain it. See *IP Address Determination*, page 93 for details.

---



## ANMS

The Authentication Network Management Service dialog box allows you to set up login authorization management from external sources. It is divided into three main panels, as described below:

Authentication Network Management Service	
<b>CC Management Settings</b>	
<input type="checkbox"/> Enable CC Management	
CC Server IP:	192.168.0.100
CC Server Port:	8889
<b>RADIUS Settings</b>	
<input type="checkbox"/> Enable RADIUS	
Primary RADIUS Server IP:	192.168.0.100
Primary RADIUS Service Port:	1812
Alternate RADIUS Server IP:	192.168.0.100
Alternate RADIUS Service Port:	1645
Shared Secret:	Secret (6 characters min.)
Timeout:	3 (seconds)
Retries:	3
<b>SNMP Settings</b>	
<input type="checkbox"/> Enable SNMP Agent	
<input checked="" type="checkbox"/> Enable SNMP Trap	
Community Name for Read:	public
Community Name for Write:	private
Community Name for Trap:	public
SNMP Manager 1:	192.168.0.100
SNMP Manager 2:	
SNMP Manager 3:	
SNMP Manager 4:	
Save	

### CC Management Settings:

If you want to allow authorization for the SN0108 / SN0116 through a CC (Control Center) server, check *Enable CC Management* and fill in the CC Server's IP address and the port that it listens on in the appropriate fields.

*(Continues on next page.)*

(Continued from previous page.)

### **RADIUS Settings:**

If you want to allow authorization for the SN0108 / SN0116 through a RADIUS server, do the following:

1. Check *Enable RADIUS*.
2. Fill in the IP addresses and Service Ports for the Primary and Alternate RADIUS servers.
3. Key the *Shared Secret* character string that you want to use for authentication between the SN0108 / SN0116 and the RADIUS Server.
4. Set the time in seconds that the SN0108 / SN0116 waits for a RADIUS server reply before it times out in the Timeout field.
5. Set the number of RADIUS retries allowed in the Retries field.
6. Click **Save** to save the information.
7. On the RADIUS server, set the access rights for each user according to the attribute information in the table, below:

<b>Attribute</b>	<b>Meaning</b>
U	(User) The user has the authority to access and configure some ports. This attribute must be specified for all users who access the system.
T	(True) The user has the authority to access and configure the ports that are specified with it.
F	(False) The user cannot configure any ports.
A	(All) The user has the authority to access and configure all ports.

*Example:*

U, T, 2, 3, 5, 6, 12, 16

The user can access and configure ports 2, 3, 5, 6, 12, and 16.

- 
- Note:**
1. The characters are not case sensitive. Upper or lower case work equally well.
  2. Characters are comma delimited.
  3. An invalid character in the string will prohibit access to the SN0108 / SN0116 for the user.
-

**SNMP Settings:**

If you want to use SNMP to help with your installation management:

1. Check *Enable SNMP Agent*.
2. Once SNMP Agent has been enabled, the *SNMP Trap* checkbox becomes active. If you want to enable SNMP trapping, click to put a check in the checkbox.
3. Key in passwords for the *Community Name* fields. We recommend replacing the defaults (public, private) with an alphanumeric string of at least 8 characters.
4. Key in the IP addresses of the computers that will automatically be notified of SNMP trap events in the *SNMP Manager* fields.
5. When you have finished making all your entries, click **Save**, to save them.

---

**Note:** MIB definitions for the SN0108 / SN0116 are provided on the CD that came with this package.

---



## **OOBC**

OOBC (Out of Band Configuration), provides the ability to access the SN0108 / SN0116 via a serial connection. This can either be a direct serial connection from a local computer, or a dial in connection via modem.

When you click the *OOBC* icon, the following dialog box appears:

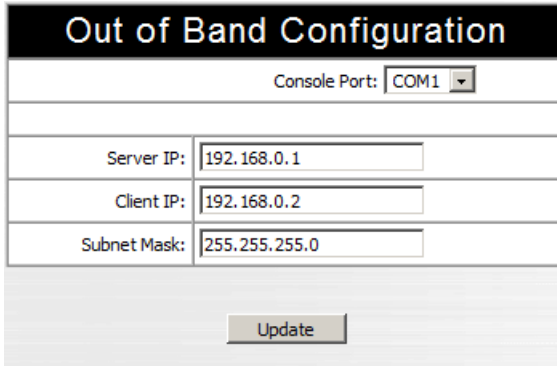

Out of Band Configuration	
Console Port:	COM1
Server IP:	192.168.0.1
Client IP:	192.168.0.2
Subnet Mask:	255.255.255.0
<input type="button" value="Update"/>	

1. Select which port will be used for the Console Port. The Console Port is the one that you connect the terminal or modem to for OOB communication. The default is Port 1 (COM1), but you can use any of the ports as long as you specify which one it is, here.
2. Specify the SN0108 / SN0116's IP address in the *ServerIP* field.
3. Specify the IP address of the device that will connect to the SN0108 / SN0116 in the *ClientIP* field.
4. Click **Update** to save the information.

The various ways to access the SN0108 / SN0116 with an OOB connection, are described in Chapter 6.



## Date / Time

The Date / Time function allows you to set the SN0108 / SN0116's date and time. When you click the *Date / Time* icon, the following dialog box appears:

**Date / Time**

---

**Current System Time**

Sys. Date (yyyy-mm-dd)

Sys. Time (hh:mm:ss)

---

**New System Time**

Synchronize with computer time

Date (yyyy-mm-dd)

Time ( hh:mm:ss )

Set manually

Date (yyyy-mm-dd)

Time ( hh:mm:ss )

Synchronize with NTP server

---

**SN0108's Time Zone**

Time Zone:

Enable daylight saving time (Summer Time)

The date and time that the SN0108 / SN0116 is currently set to appear in the upper section. The large middle section offers three methods to set new date and time parameters:

- ◆ Synchronizing the date and time with your computer's date and time
- ◆ Setting the date and time manually
- ◆ Synchronizing the date and time with the date and time of an NTP server on the internet

- 
- Note:**
1. If you enable *Synchronize with computer time*, the Date and Time fields are filled with the date and time settings of your computer.
  2. If you enable *Set Manually*, key in the Date and Time in the corresponding fields.
  3. If you enable *Synchronize with NTP server*, select the time zone that corresponds to the SN0108 / SN0116's location from the list box in the *Time Zone* panel. If you are behind a firewall, you must enable a port for the NTP server.
- 

- ◆ Click **Save** to save your changes.



## **Firmware**

There are two functions provided under Firmware: Firmware Upgrade, and Private Certificate.

### **Firmware Upgrade**

The Firmware Upgrade function provides a smooth, automated process for upgrading the SN0108 / SN0116's firmware. New firmware upgrade packages are posted on our web site as they become available. Check the site regularly to find the latest packages.

To upgrade your firmware, do the following:

1. From your computer, go to our Internet support site and choose the SN0108 / SN0116 to get a list of available Firmware Upgrade Packages.
2. Choose the Firmware Upgrade Package you want to install (usually the most recent), and download it to your computer.
3. From the computer that you downloaded the upgrade file to, log into the SN0108 / SN0116.
4. Click the *Firmware* icon. A dialog box similar to the one below appears:

The screenshot shows a dialog box titled "Firmware Upgrade". It contains a checked checkbox labeled "Check Firmware Version". Below the checkbox is a text input field labeled "Firmware Image File:" with a "Browse..." button to its right. At the bottom center of the dialog is an "Upgrade" button.

5. Click the *Browse* button; navigate to the upgrade file on your computer, and select it.
6. Click **Upgrade** to perform the upgrade.

---

**Note:** 1. If you enable *Check Firmware Version*, the upgrade function compares the station's firmware level with that of the upgrade files. If it finds that the SN0108 / SN0116's current version is equal to, or higher than, the upgrade version, it won't overwrite the SN0108 / SN0116's version.

2. If you do not enable *Check Firmware Version*, the Utility installs the upgrade files without checking whether they are a higher level, or not.
-



## Private Certificate

When logging in over a secure (SSL) connection, a signed certificate is used to verify that the user is logging in to the intended site. For enhanced security, the *Private Certificate* section allows you to use your own private encryption key and signed certificate, rather than the default ATEN certificate.



The screenshot shows a web form titled "Private Certificate". It contains two input fields: "Private Key:" and "Certificate:". Each field has a "Browse..." button to its right. Below these fields are two buttons: "Upload" and "Restore default".

There are two methods for establishing your private certificate: generating a self-signed certificate; and importing a third-party certificate authority (CA) signed certificate.

### Generating a Self-Signed Certificate

If you wish to create your own self-signed certificate, a free utility – `openssl.exe` – is available for download over the web. See *Self-Signed Private Certificates*, page 95 for details about using OpenSSL to generate your own private key and SSL certificate.

### Obtaining a CA Signed SSL Server Certificate

For the greatest security, we recommend using a third party certificate authority (CA) signed certificate. To obtain a third party signed certificate, go to a CA (Certificate Authority) website to apply for an SSL certificate. After the CA sends you the certificate, save it to a convenient location on your computer.

### Importing the Private Certificate

To import the private certificate, do the following:

1. Click **Browse** to the right of *Private Key*; browse to where your private encryption key file is located; and select it.
2. Click **Browse** to the right of *Certificate*; browse to where your certificate file is located; and select it.

Click **Upload** to complete the procedure.

## Device Management Configuration

The buttons in the bar along the left side of the SN0108 / SN0116 web page are used to manage and access the devices connected to the SN0108 / SN0116's COM ports.

This section discusses the functions available to administrators and, in the case of port configuration, users with configuration permission. The functions available to ordinary users are discussed in Chapter 5, *Browser Operation*.

### Port Config

The administrator and users with port configuration permission (see *User Manager*, page 37), can set up the operating parameters for each of the SN0108 / SN0116's ports by clicking the *Port Config* button to bring up the Port Configuration dialog box:

Port Configuration			
Select	Port Number	Port Name	TCP Port
<input checked="" type="radio"/>	COM1	Console	-
<input type="radio"/>	COM2	COM2	5002
<input type="radio"/>	COM3	COM3	5003
<input type="radio"/>	COM4	COM4	5004
<input type="radio"/>	COM5	COM5	5005
<input type="radio"/>	COM6	COM6	5006
<input type="radio"/>	COM7	COM7	5007
<input type="radio"/>	COM8	COM8	5008

(Continues on next page.)

(Continued from previous page.)

## Property Settings

To set up the serial communications parameters for a port, select it, then click the *Property Settings* button at the bottom of the page:

Port Property Settings	
Port ID:	<input type="text" value="COM2"/>
Port Name:	<input type="text" value="COM2"/>
Baud Rate:	<input type="text" value="9600 bps"/>
Data Bits:	<input type="text" value="8 bits"/>
Parity:	<input type="text" value="None"/>
Stop Bits:	<input type="text" value="1 bit"/>
Flow Control:	<input type="text" value="None"/>
Enable Toggle DTR:	<input type="text" value="No"/>
Online Detect:	<input type="text" value="DSR"/>
Out CRLF Translation:	<input type="text" value="None"/>
Suspend Character:	<input type="text" value="D"/>
Operating Mode:	<input type="text" value="Console Management"/>
Timeout:	<input type="text" value="3"/> min. (0:Disable)
Authorized Operators:	<input type="text" value="administrator"/>
<input type="button" value="Update"/>	

The meanings of the settings are given in the following table:

Setting	Meaning
Port ID	Each port on the SN0108 / SN0116 has a port ID number (COM1 - COM8 for the SN0108, or COM1 - COM16 for the SN0116). The Port ID field displays the number of the port that is being configured.
Port Name	You can give a port an appropriate name by editing the <i>Port Name</i> field.
Baud Rate	This sets the port's data transfer speed. Choices are from 300 – 115200 (drop down the list to see them all). Set this to match the baud rate setting of the connected device. Default is 9600 (which is a basic setting for many serial devices).
Data Bits	This sets the number of bits used to transmit one character of data. Choices are: 5, 6, 7 and 8. Set this to match the data bit setting of the connected device. Default is 8 (which is the default for the majority of serial devices).

(Continues on next page.)

(Continued from previous page.)

Setting	Meaning
Parity	This bit checks the integrity of the transmitted data. Choices are: Even, Odd, None, Mark, and Space. Set this to match the parity setting of the connected device. Default is None (which is the default for the majority of serial devices).
Stop Bits	This indicates that a character has been transmitted. Set this to match the stop bit setting of the connected device. Choices are: 1, 1.5, and 2. Default is 1 (which is the default for the majority of serial devices).
Flow Control	This allows you to choose how the data flow will be controlled. Choices are: None, Hardware (RTS/CTS), and XON/XOFF. Set this to match the flow control setting of the connected device. Default is None.
Enable Toggle DTR	Enabling this parameter allows the DTR signal to toggle between disabled and enabled when the port is occupied. Choices are: No, and Yes. Default is No. <b>Note:</b> For some devices, in order for Enabled to work correctly, you must first disable DTR (select <i>No</i> , then click <b>Update</b> ), then Enable it (select <i>Yes</i> , then click <b>Update</b> ).
Online Detect	This allows you to set the DSR signal to detect online status or not. Choices are: None and DSR. Default is DSR.
Out CRLF Translation	This allows you to select whether to send a Carriage Return and Line Feed signal (CRLF), or only a Carriage Return signal (CR). Choices are: None (which sends CRLF) and CRLF to CR (which only sends CR), Default is None. <b>Note:</b> If your device outputs double spaced lines, it means that a line feed is automatically added to a carriage return signal. In that case, choose CRLF to CR.
Suspend Character	The <i>Suspend character</i> is used to bring up the Suspend Menu in Telnet sessions (see <i>Telnet</i> , page 47). <b>Note:</b> Valid characters are from A—Z, except H, I, J, and M. Those four characters may not be used.

(Continues on next page.)

(Continued from previous page.)

Setting	Meaning
Operating Mode	<p>The choices are:</p> <p><b>Console Management:</b> In this mode, users establish a Telnet or SSH session under the SN0108 / SN0116 to manage a server or serial device connected to the port. Users can log in using the browser Telnet function, a direct Telnet session, SSH or PuTTY. This mode can also be used for Out-of-Band operation via the SN0108 / SN0116's Console Port. See <i>Out of Band Operation</i>, Chapter 6.</p> <p><b>Raw TCP Mode:</b> This mode is used with socket programming to directly control the device's data transmission without the need for serial port control or serial modem signal control. Only data is transmitted (using IP as the protocol).</p> <p><b>Note:</b> When you use the IP address you must also specify the port number. For example: 192.168.0.200 5003.</p> <p>For security purposes, access to the port can be limited to specific IP addresses. See <i>Direct Access</i>, page 40, for further details.</p> <p><b>Real COM Port:</b> Used with a virtual COM port driver on the local machine (See <i>Real COM Port Management</i>, Chapter 7 for virtual port management details.) The device connected to this port appears as if it were a device directly connected to a COM port on the local computer. Data transmission between the device and the local computer takes place over the virtual COM port to the SN0108 / SN0116.</p> <p>This mode is useful with serial devices such POS terminals, Bar Code Readers, Serial printers, etc. In addition, this mode can be used with other Altusen management products, such as the PN9108 Power Over the NET™.</p> <p>As with Raw TCP Mode, access to the port can be limited to specific IP addresses with the <i>Direct Access</i> function (see page 40).</p>
Timeout	<p>If there is no input on this port for the amount of time set here, the port is released for use by another user.</p> <p><b>Note:</b> This field does not appear if the port is selected as a Console port. (See <i>OOBC</i>, page 28, for selection details.)</p>
Authorized Operators	<p>The <i>Authorized Operators</i> field indicates the users that are authorized to operate the port (see <i>User Manager</i>, page 37). The information in this field is for viewing purposes only. It can't be changed on this page.</p>

- ◆ When you have finished making your choices, click **Update** to save them.
- ◆ To abandon your choices without saving them, simply leave the page.

**Alert Settings:**

The Port Alert Settings dialog box provides a way for you to be informed via email about problems that may occur on the devices connected to the SN0108 / SN0116's ports. When a device has a problem - such as a critical error that requires a reboot - debug messages can be sent through its COM port.

**Note:** This function only works when the Operating Mode is set to *Console Management* (see *Operating Mode*, page 35).

When the SN0108 / SN0116 receives such a message, it can send an email to inform the user specified here of the problem. You can have up to 10 types of alert emailed to you when a device generates them.

To configure a port to provide alert notification, do the following:

1. Select it in the *Select* column of the Port Configuration dialog box (see page 32), then click the *Alert Settings* button. A dialog box, similar to the one below, appears:

Port Alert Configuration	
Port ID:	COM1
Alert String 1:	
Alert String 2:	
Alert String 3:	
Alert String 4:	
Alert String 5:	
Alert String 6:	
Alert String 7:	
Alert String 8:	
Alert String 9:	
Alert String 10:	
<input type="checkbox"/> Enable report from the following SMTP Server	
SMTP Server:	
<input type="checkbox"/> My server requires authentication	
Account Name:	
Password:	*****
From:	
To:	
Update	

2. Use the *Alert String* fields to specify the alerts you want to receive.

3. Enable the *Enable report to the following address* checkbox, and key in the IP address of your SMTP server.
4. If your server requires authentication, put a check in the *My server requires authentication* checkbox.
5. Key in the appropriate account information in the *Account Name*, *Password*, and *From* fields.
6. Key in the email address of where you want the report sent to in the *To* field.
7. When all of your configuration settings have been made, click **Update** to save the information.

After setting up this page, whenever one of the specified alerts is generated, you will be informed by email of its occurrence.

## **User Manager**

Clicking the *User Manager* button brings up the User Management dialog box. If this is the first time you are accessing this function, or no user accounts have been created yet, the following screen displays:



Click **New** to begin setting up user accounts. See p. 38 for adding, editing, and deleting user accounts.

If user accounts have been set up, the User Manager dialog box appears:

User Manager			
Select	Login Name	Config	Ports
<input checked="" type="radio"/>	frosty	Enabled	All
<input type="radio"/>	rjf111	Disabled	2,3,4,5,6,7,10,11,14
<input type="radio"/>	fernando	Disabled	9,10,11,12,13,14,15,16
<input type="radio"/>	jessica	Enabled	All

This dialog box allows the administrator to add, delete, and edit user accounts. Up to 15 user accounts can be established. Operators must provide the Usernames and Passwords established here, in order to log in.

### Deleting an Account

To delete a user account, select it and click **Delete**.

### Adding an Account:

To add a user, click **Add**. The *User Information* dialog box appears:

User Information				
Username:	<input type="text"/>	Comments:	<input type="text"/>	
Password:	<input type="text"/>	Reenter password:	<input type="text"/>	
<input type="checkbox"/> Port Config Permission				
Enable	Port Number	Port Name	Top Port	Shared
<input checked="" type="checkbox"/>	COM2	COM2	5002	Yes
<input checked="" type="checkbox"/>	COM3	COM3	5003	Yes
<input checked="" type="checkbox"/>	COM4	COM4	5004	Yes
<input checked="" type="checkbox"/>	COM5	COM5	5005	Yes
<input checked="" type="checkbox"/>	COM6	COM6	5006	Yes
<input checked="" type="checkbox"/>	COM7	COM7	5007	Yes
<input checked="" type="checkbox"/>	COM8	COM8	5008	Yes

1. Key in the user's Username and Password (up to 16 characters for each).
2. Reenter the password to confirm that it is correct.
3. Key in any Comments you wish to make concerning the user. (optional)



- If you want the user to have Port Configuration permission, put a check in the *Port Config Permission* checkbox. Otherwise, leave it blank.

---

**Note:** 1. *Port Configuration* is where the Port Numbers and Names that appear in this dialog are set. See *Port Config*, page 32 for port configuration information.

- The term “Yes” in the *Shared* column means that other users have access permission to the port.
- 

- If there are any ports that you do not want the user to access, remove the check from the *Enable* checkbox.
- Click **Add** to save your changes.

### Editing an Account:

- To Edit a user account, select the user, then click **Edit**. The user’s *User Information* dialog box appears:

User Information				
Username:	<input type="text" value="frosty"/>	Comments:	<input type="text"/>	
Password:	<input type="text"/>	Reenter password:	<input type="text"/>	
<input checked="" type="checkbox"/> Port Config Permission				
Enable	Port Number	Port Name	Tcp Port	Shared
<input checked="" type="checkbox"/>	COM2	COM2	5002	Yes
<input checked="" type="checkbox"/>	COM3	COM3	5003	Yes
<input checked="" type="checkbox"/>	COM4	COM4	5004	Yes
<input checked="" type="checkbox"/>	COM5	COM5	5005	Yes
<input checked="" type="checkbox"/>	COM6	COM6	5006	Yes
<input checked="" type="checkbox"/>	COM7	COM7	5007	Yes
<input checked="" type="checkbox"/>	COM8	COM8	5008	Yes
<input type="button" value="Update"/>		<input type="button" value="Back"/>		

- Make your changes in the appropriate fields and checkboxes.
- To save your changes, click **Update**.
- To exit without saving any changes, click **Back**.

## Direct Access

For security purposes, *Direct Access* can limit the users attempting to log in to *RAW TCP* ports or *Real COM* ports (see *Operating Mode*, page 35).

Direct Access IP Configuration	
IP 01:	<input type="text"/>
IP 02:	<input type="text"/>
IP 03:	<input type="text"/>
IP 04:	<input type="text"/>
IP 05:	<input type="text"/>
IP 06:	<input type="text"/>
IP 07:	<input type="text"/>
IP 08:	<input type="text"/>
IP 09:	<input type="text"/>
IP 10:	<input type="text"/>
IP 11:	<input type="text"/>
IP 12:	<input type="text"/>
IP 13:	<input type="text"/>
IP 14:	<input type="text"/>
IP 15:	<input type="text"/>
IP 16:	<input type="text"/>
IP 17:	<input type="text"/>
IP 18:	<input type="text"/>
IP 19:	<input type="text"/>
IP 20:	<input type="text"/>
IP 21:	<input type="text"/>
IP 22:	<input type="text"/>
IP 23:	<input type="text"/>
IP 24:	<input type="text"/>
IP 25:	<input type="text"/>
IP 26:	<input type="text"/>
IP 27:	<input type="text"/>
IP 28:	<input type="text"/>
IP 29:	<input type="text"/>
IP 30:	<input type="text"/>
IP 31:	<input type="text"/>
IP 32:	<input type="text"/>

If no IP addresses are specified on this page, anyone can open a TCPIP Telnet session to a RAW TCP or Real COM port by specifying the IP address and port number of the port – without having to specify a Username and Password.

Once specific IP addresses are entered here, however, only users logging in to the SN0108 / SN0116 from one of those IP addresses can have access to the RAW TCP or Real COM ports without having to specify a Username and Password.



---

**Note:** Ports must be designated as a RAW TCP or Real COM ports under the *Port Config* settings. See *Operating Mode*, page 35, for further details.

---

## Session Info

Clicking the *Session Info* button brings up the Active Sessions display:

Active Sessions								
Select	Login Name	Local User	Admin	Port	Service	IP	UP Time	Last Access
	admin	Yes	Yes	Local	HTTPS	10.0.0.58	18:29:46	18:29:47
	admin	Yes	Yes	Local	HTTPS	10.0.1.152	19:38:33	19:38:55
	rjfl	Yes	-	Local	HTTPS	10.0.1.97	20:27:01	20:27:34

This display lets the administrator see at a glance all the users currently logged into the SN0108 / SN0116, and provides information about each of their sessions.

It also gives the administrator the option of forcing a user logout by selecting the user and clicking **End Session**.

## **Sys Info**

The System Information dialog box provides information about all aspects of the SN0108 / SN0116's configuration:

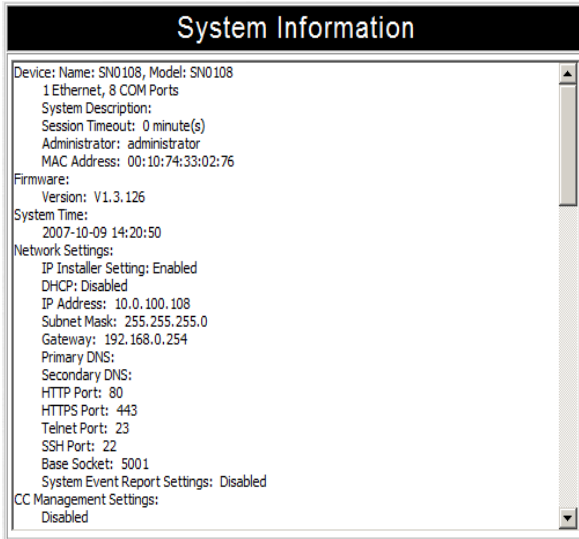

## Log

Clicking the *Log* button brings up the Event Log dialog box:

Event Log		
<input checked="" type="radio"/> Today	<input type="radio"/> All	<input type="radio"/> Selected
From : ( YYYY/MM/DD )	2007/10/09	
To : ( YYYY/MM/DD )	2007/10/09	
OK		

The SN0108 / SN0116 maintains a log file of the events that take place on it. This dialog box allows you to select the range of events you wish to view:

- ◆ Choose **Today** then click **OK** to see a listing of only today's events.
- ◆ Choose **All** then click **OK** to see a listing of events for the entire log file.
- ◆ Choose **Selected**; key in the desired range of dates in the *From* and *To* fields; then click **OK** to see a listing of events for a specific time period.

---

**Note:** The maximum number of events contained in the log file is 512. Once that amount is reached, the oldest events are discarded as new ones are recorded.

---

*(Continues on next page.)*

*(Continued from previous page.)*

Once you make a choice and click OK an Event Log List, similar to the one below, appears:

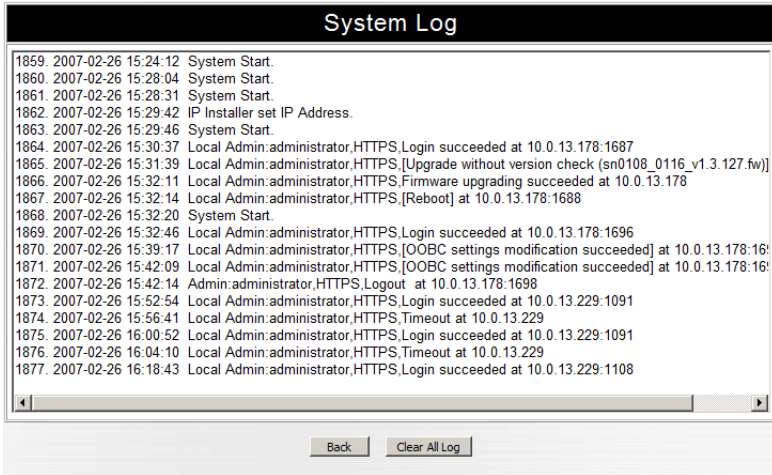

When you have finished viewing the event list:

- ◆ To return to the Event Log dialog box, click **Back**.
- ◆ To erase the contents of the entire log file, click **Clear ALL Log**.
- ◆ To exit, select a different function from the button bar.





# Chapter 5

## Browser Operation

### Overview





---

Once you have logged in and the Main Screen appears (see *The SN0108 / SN0116 Main Screen*, page 20). The bar along the left side is used to configure and control access to each of the SN0108 / SN0116's COM ports. The functions of each of the buttons is described in the following table:

Button	Authorization	Function
	All	Clicking this button brings up the Serial Port Status screen. This is the same screen that displays after a log in (see page 20). Users can see the status of each of the devices attached to the SN0108 / SN0116's COM ports.
	All	Clicking this button brings up the Telnet page. This page allows the administrator and all users to open telnet sessions to connect to the devices attached to the SN0108 / SN0116's COM ports. See p. 47 for details.
	Administrator and Permitted Users	This page allows the administrator and users with configuration permission (see <i>User Manager</i> , page 37), to set up the COM port parameters for each of the SN0108 / SN0116's COM ports (see <i>Port Config</i> , page 32).
	All	This button has two effects depending on whether the administrator or an ordinary user clicks it: <ul style="list-style-type: none"><li>◆ The administrator can use this function to Create, Edit, and Delete user profiles (see <i>User Manager</i>, page 37, for details).</li><li>◆ Ordinary users can only use this function to change their passwords and personal information (see p. <i>User Manager</i>, page 51).</li></ul> <b>Note:</b> Operators who have logged in via a RADIUS server (see <i>RADIUS Settings</i> ., page 26) can view User Manager information, but cannot make any changes to that information.

(Continues on next page.)

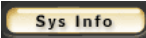
(Continued from previous page.)

Button	Authorization	Function
	Administrator Only	For security purposes, Direct Access can limit the users attempting to log in to ports that have been specified as RAW TCP Ports and Real COM Ports (see <i>Operating Mode</i> , page 35).
	Administrator Only	This page allows the administrator to see information about all the users who are currently logged into the SN0108 / SN0116 (see p. 41)
	Administrator Only	This page shows information about the SN0108 / SN0116's configuration (see p. 42)
	Administrator Only	Clicking this button brings up the <i>Event Log</i> dialog box which allows the administrator to view all of the events that took place on the SN0108 / SN0116 (see p. 43 for details).

- 
- Note:**
- Buttons are only active for the functions that the user is authorized to perform.
  - Administrator functions (including *Port Config*) are discussed in Chapter 4.
  - The *Telnet*, and *User Manager* operations are discussed in the sections that follow.
-



## Telnet

To access any of the device attached to the SN0108 / SN0116's COM ports, click the **Telnet** button. A screen similar to the one below appears:

Telnet Selection			
Select	Port Number	Port Name	TCP Port
<input checked="" type="radio"/>	Local	-	23
<input type="radio"/>	COM2	COM2	5002
<input type="radio"/>	COM3	COM3	5003
<input type="radio"/>	COM5	COM5	5005
<input type="radio"/>	COM6	COM6	5006
<input type="radio"/>	COM7	COM7	5007
<input type="radio"/>	COM8	COM8	5008
<input type="radio"/>	COM9	COM9	5009
<input type="radio"/>	COM10	COM10	5010
<input type="radio"/>	COM11	COM11	5011
<input type="radio"/>	COM12	COM12	5012
<input type="radio"/>	COM13	COM13	5013
<input type="radio"/>	COM14	COM14	5014
<input type="radio"/>	COM15	COM15	5015
<input type="radio"/>	COM16	COM16	5016

1. Select the port you would like to access.

---

**Note:** You must have permission in order to access a port (see *User Manager*, page 37 for details).

---

2. If you want to view the port history, click the *View History* button. A screen showing the Telnet activity that took place on the device connected to the port appears. Click the browser's *Back* button to return to the Telnet page.

3. To access the device connected to the port, click **Connect**.

The SN0108 / SN0116 opens a Telnet session and a screen similar to the one below appears:

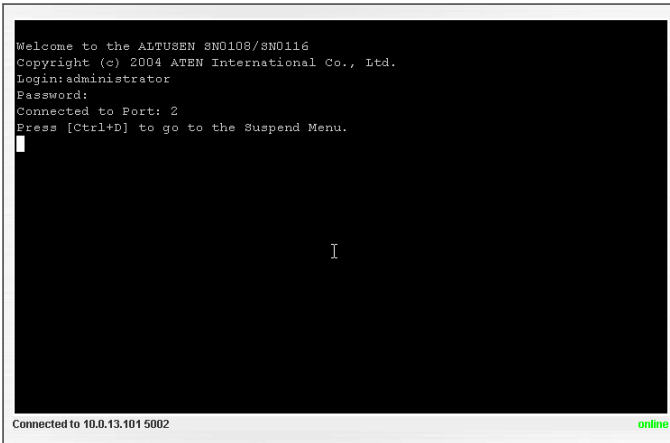

```
Welcome to the ALTUSEN SN0108/SN0116
Copyright (c) 2004 ATEN International Co., Ltd.
Login:administrator
Password:
Connected to Port: 2
Press [Ctrl+D] to go to the Suspend Menu.
|
```

Connected to 10.0.13.101 5002 online

4. If you are connected to a computer and want to go to a terminal session or command line to operate it, Press **[Enter]**. When you have finished with the session, **log out**, then bring up the Main Menu.

---

**Note:** Be sure to log out before bringing up the Main Menu, otherwise, another user can access the device without having to log in.

---

5. If you are connected to another device, enter the command that brings it up. For example, if you are connected to a PN9108, key in: **[???] [Enter]**

*(Continues on next page.)*

(Continued from previous page.)

6. To display the Suspend Menu, Press **[Ctrl+x]**.

Where **x** represents the Suspend Character set by the Administrator (see the *Property Settings* dialog box under *Port Configuration*, p. 33). The screen will prompt you as to the correct character. In this example, it is **[Ctrl+D]** (see the prompt on the previous screenshot). The following screen appears:



```
SN0108/SN0116  Suspend Menu
=====
1. Send Break
Q. Goto Main Menu

Select one: █

I

Connected to 10.0.13.101 5002 online
```

7. Press **1** to issue a *Send Break* command to the attached device. This is used to put a Sun system in *OK Mode*.
8. Press **Q** to bring up the Main Menu:

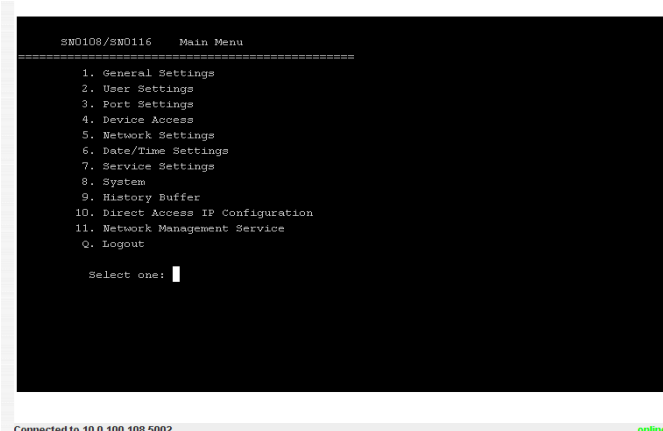

```
SN0108/SN0116  Main Menu
=====
1. General Settings
2. User Settings
3. Port Settings
4. Device Access
5. Network Settings
6. Date/Time Settings
7. Service Settings
8. System
9. History Buffer
10. Direct Access IP Configuration
11. Network Management Service
Q. Logout

Select one: █

Connected to 10.0.100.108 5002 online
```

The Main Menu is the text based equivalent of the browser configuration and control functions. The descriptions and explanations for the Browser Operations apply to the submenu functions presented here, as well.

- 
- Note:**
1. As with the browser version, access to many of these submenus are restricted to the administrator or users with configuration permission. If you select a submenu that you are not authorized for, nothing will happen.
  2. Some of the submenus do not have an *Exit* choice. In these cases, you can return to the previous menu without making any changes by pressing **Enter** twice.
  3. You can bring up the Main Menu at any time during your session.
- 

When you have finished with your session, bring up the Main Menu and press **Q** to log out.

---

## Port Configuration

---

Since only the administrator and users with port configuration permission can access this function, it is discussed in the Administration chapter (see *Port Config*, page 32).

---

## User Manager

---

For users, clicking the *User Manager* button brings up their User Information dialog box:

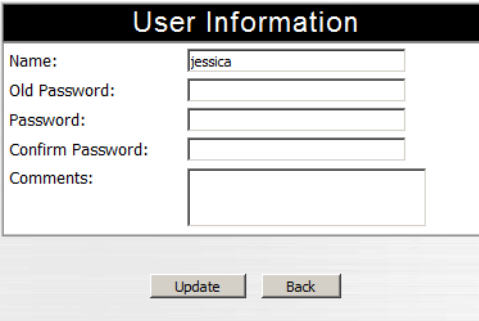

The image shows a web-based dialog box titled "User Information". It contains several input fields: "Name" with the value "jessica", "Old Password", "Password", and "Confirm Password", all of which are currently empty. Below these is a larger "Comments" text area. At the bottom of the dialog are two buttons: "Update" and "Back".

They can use this dialog box to change their password and *Comments* information

- ♦ To save any changes, click **Update**.
- ♦ To exit without saving any changes, click **Back**.

This Page Intentionally Left Blank

# Chapter 6

## Out of Band Operation

### Overview

---

In case the network goes down, or the SN0108 / SN0116 cannot be accessed with the usual browser based method for some other reason, the SN0108 / SN0116 can be reached via several additional *Out of Band* (OOB) methods. These include HyperTerminal, PPP, Telnet, and SSH. Each of these is described in the sections that follow.

### HyperTerminal

---

HyperTerminal is a program included with Windows. It can be used to establish either a direct terminal connection, or an indirect (phone in) terminal connection. Both configurations are discussed below.

#### Direct HyperTerminal Connection

##### **Setup:**

To set up a direct HyperTerminal connection, do the following:

1. Use Ethernet cable and a DTE-to-DTE adapter to connect one of the SN0108 / SN0116's serial ports to a COM port on a PC (see the *Installation* section, pages 13 and 14).

- 
- Note:** 1. See *RJ-45 to Serial Adapters*, page 96, for details on choosing the appropriate adapter. The usual choice for connecting to a PC is SA0141.
2. In the examples that follow we use COM1. If you use a different COM port, change the settings accordingly.
  3. Be sure that the port you specify as the Console Port in the OOB dialog box (see *OOBC*, page 28) matches the port that you are connecting the PC to. Change the setting, if necessary.
-

2. On your PC, run the HyperTerminal program:

Start → Programs → Accessories → Communications → HyperTerminal → Hypertm.exe

The following dialog box appears:

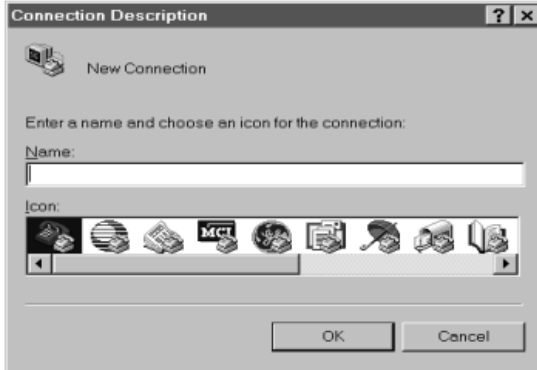

3. Key a name to describe the connection in the *Name* field (we chose Com1Test); select an icon to represent the connection; then click **OK**. A dialog box similar to the one below comes up:

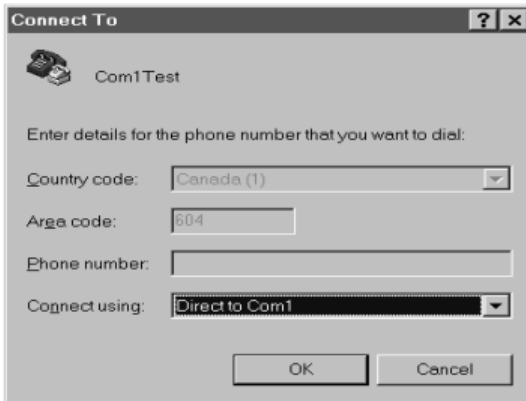



4. For the *Connect using:* field, select *Direct to COM1* (assuming you are using COM1 on your PC), then click **OK**. A *Port Setting* dialog box similar to the one below comes up:

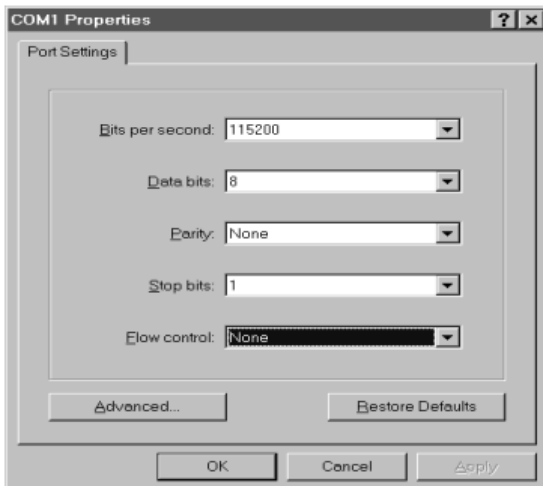

5. For OOBC connections, the SN0108 / SN0116's serial port settings and the computer's COM port settings must be the same. Change the settings in your dialog box (if necessary), so that they match the SN0108 / SN0116's Console Port settings (see *Port Config*, page 32, for details), then click OK.

---

**Note:** The SN0108 / SN0116's default settings are 9600 bps; 8 Data bits; No Parity; No Stop bits, but you can change these to something more suitable to your installation as long as they both match.

---

- When the HyperTerminal screen appears, open the File menu and select: Properties → Settings. The following dialog box displays:

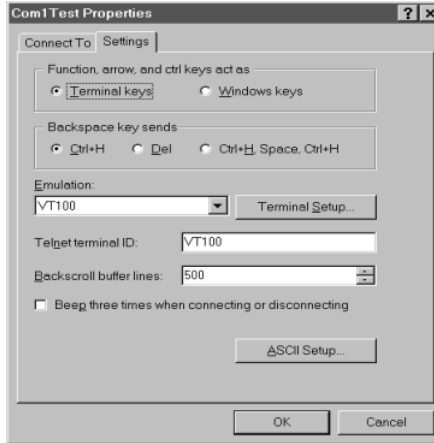

- Change the settings (if necessary), so that they match the settings shown in the dialog box, then click **ASCII Setup...** The *ASCII Setup* dialog box comes up:

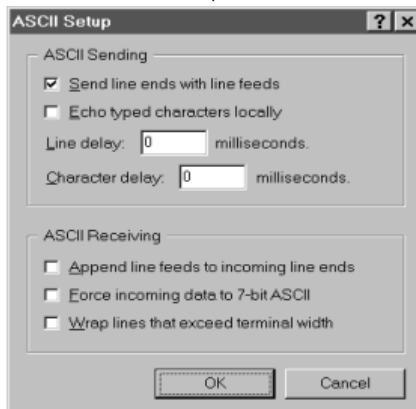

- Change the settings (if necessary), so that they match the settings shown in the dialog box, then click OK.

9. Close the HyperTerminal Window. When Windows asks if you want to disconnect, click **Yes**. When Windows asks if you want to save the session, click **Yes**.

This completes the HyperTerminal setup. For Windows NT, 2000, XP and Windows Server 2003 systems, a HyperTerminal icon that connects you to the SN0108 / SN0116 is created on the desktop. For Windows 98 and ME, you must access HyperTerminal from the Windows Start Menu.

**Logging In:**

1. Double click the HyperTerminal icon on your desktop.
2. In the VT100 terminal window, key in:  
  
    [Ctrl + D]  
  
    A login prompt appears.
3. Key in your Username and Password to bring up the SN0108 / SN0116's main menu.

## **Indirect HyperTerminal Connection**

This method uses HyperTerminal to phone into the SN0108 / SN0116 from a remote location.

### **Setup:**

1. Set up your hardware configuration to match the diagram, below

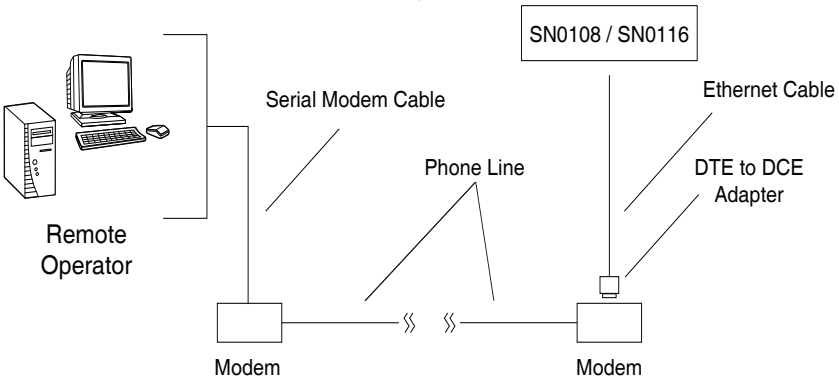

- ◆ On the remote computer side, use a standard 9 pin serial modem cable (pin 2 to pin 2; pin 3 to pin 3) to connect the computer to the modem.
- ◆ On the SN0108 / SN0116 side, use Cat 5 cable and an RJ-45 to Serial adapter to connect a modem to any of its serial ports (see the *SN0108D / SN0116D PC Installation Diagram*:, page 14). Also see *RJ-45 to Serial Adapters*, page 96, for details on choosing the appropriate adapter. The usual choice for connecting to a modem is SA0142.

---

**Note:** Be sure that the port you specify as the Console Port in the OOBC dialog box (see p. 28) matches the port that you connect the modem to. Change the setting, if necessary.

---

2. Create a HyperTerminal connection.
  - a) Start with Step 2 of the Direct HyperTerminal Setup section (p. 54).
  - b) For *Connect using*: in Step 4, select the type of modem connected to your computer from the list. If your modem doesn't appear in the list, select *Standard 28800bps Modem*.
  - c) Follow Steps 5-9 to complete the setup and create the connection icon.

This completes the HyperTerminal setup. For Windows NT, 2000, XP and Windows Server 2003 systems, a HyperTerminal icon that connects you to the SN0108 / SN0116 is created on the desktop. For Windows 98 and ME, you must access HyperTerminal from the Windows Start Menu.

### Final Check:

To make sure that the modem and COM port are correctly installed:

1. Open the Control Panel:

My Computer → Control Panel

2. Open the *Make New Connection* folder.

If all went well, you should see an entry with the name you assigned for this connection.

3. Open the Device Manager:

My Computer → Control Panel → System → Device Manager

Your *Modem* and *Ports* entries should look similar to the image below

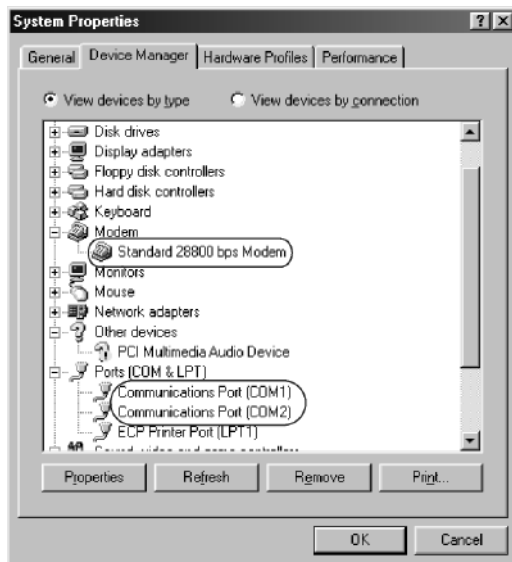

## **Logging In**

1. Double click the HyperTerminal icon on your desktop.

2. In the VT100 terminal window, key in:

```
atdt [modem telephone number] [Enter]
```

The terminal responds with:

```
CONNECT115200
```

3. Wait at least 60 seconds, then key in:

```
[Ctrl+D]
```

4. Key in your Username and Password to bring up the SN0108 / SN0116's Main Menu.

## PPP (Dial In) Connection

---

This type of connection works directly through the COM port.

### Direct PPP Connection

#### Setup:

To set up a direct PPP connection, do the following:

1. Use Ethernet cable a DTE-to-DTE adapter to connect one of the SN0108 / SN0116's serial ports to a COM port on a PC (refer to *SN0108 / SN0116 PC Installation*, page 11 or *SN0108D / SN0116D PC Installation*, page 13, if necessary).

---

**Note:** 1. See *RJ-45 to Serial Adapters*, page 96, for details on choosing the adapter. The usual choice for connecting to a PC is SA0141.

2. In the examples that follow we use COM1. If you use a different COM port, change the settings accordingly.
- 

2. On your PC, run the *Make New Connection* setup program:

Start → Programs → Accessories → Communications →  
Make New Connection

The following dialog box appears:

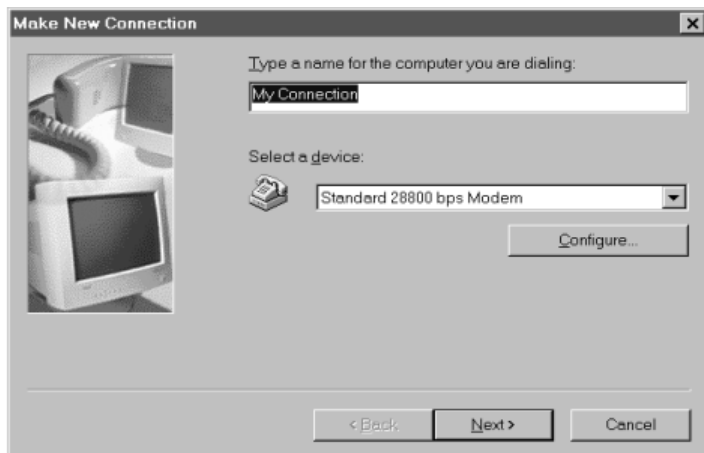

3. Key a descriptive name for the connection in the top text box; select *Standard 28800 bps Modem* for the device; then click **Configure**.

4. In the *Modem Properties* dialog box that comes up change the dialog box settings (if necessary), so that the COM port is correct, then click OK.

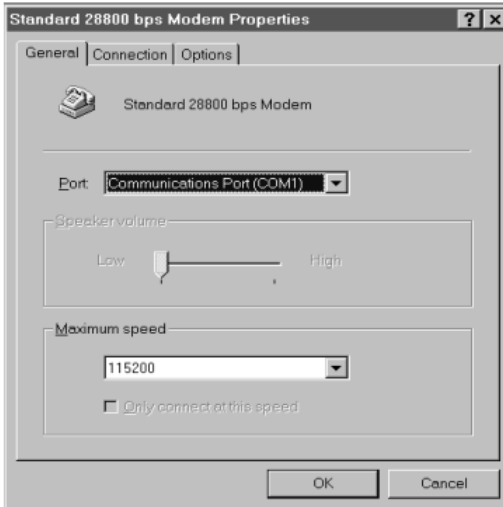

5. Click the **Connection** tab to see the connection setup page:

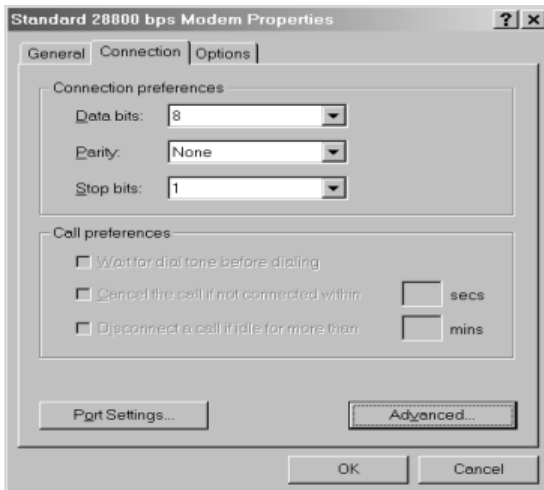

6. Change your settings (if necessary), so that they match the settings shown in the figure above then click **Advanced**.



7. In the *Advanced Connection Settings* dialog box enable *Use flow control*; select **Hardware (RTS/CTS)**; then click **OK** to return to the Connection page.

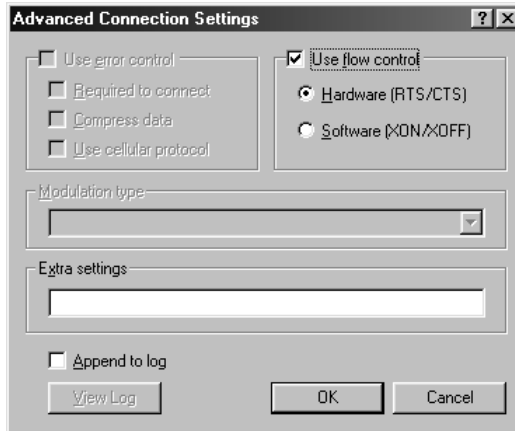

8. Click **OK** (at the bottom of the Connection page; then click **Next**. The following dialog box appears:

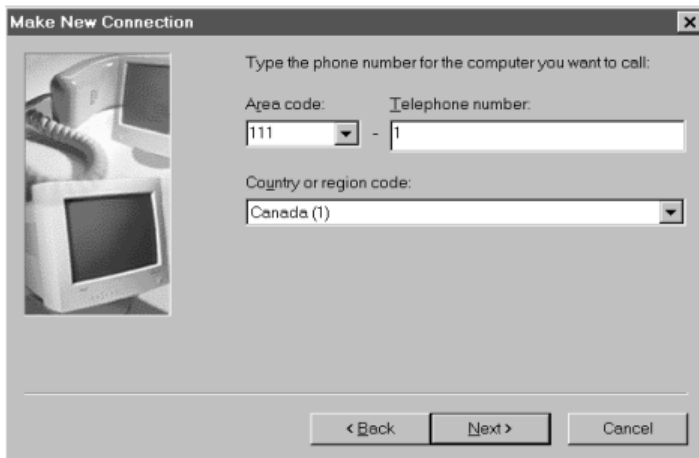

9. Key in anything you like for these fields, then click **Next**.
10. Click **Finish**.

A new icon that you can use to connect to the SN0108 / SN0116 is created in the *Dial-up Network* folder. This completes the Direct Dial In setup.

**Finishing Up:**

The SN0108 / SN0116's serial port settings and the computer's COM port settings must be the same. Change the SN0108 / SN0116's settings for the port you are connecting the computer to (see *Port Config*, page 32), so that they match the ones you just set in the dialog boxes (as shown in the table below):

Parameter	Value
Bit per second:	115200
Data bits:	8
Parity:	None
Stop bits:	1
Flow control:	Hardware (RTS/CTS)

**Logging In:**

1. Double click the icon you created in the *Dial-up Network* folder.
2. Key in your Username and Password, then click **Connect**.
3. Use Telnet, SSH, or your browser to access the SN0108 / SN0116 the same way as if you were accessing it over the net.

## Indirect PPP Connection

This method uses a modem connection to phone into the SN0108 / SN0116 from a remote location.

### Setup:

1. Set up your hardware configuration to match the diagram, below:

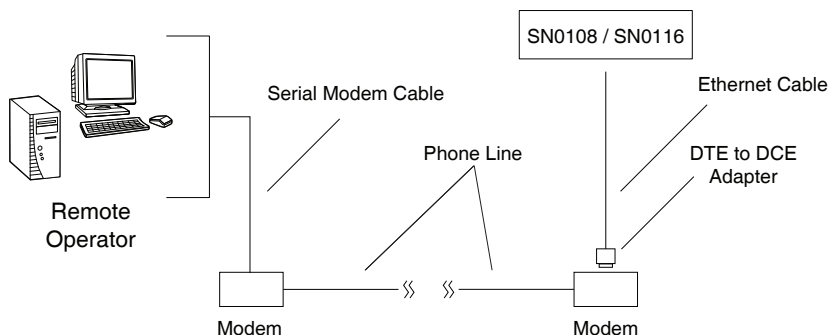

- ◆ On the remote computer side, use a standard 9 pin serial modem cable (pin 2 to pin 2; pin 3 to pin 3) to connect the computer to the modem.
- ◆ On the SN0108 / SN0116 side, use Cat 5 cable and an RJ-45 to Serial adapter to connect a modem to any of its serial ports (see the *SN0108D / SN0116D PC Installation Diagram*., page 14). Also see *RJ-45 to Serial Adapters*, page 96, for details on choosing the appropriate adapter. The usual choice for connecting to a modem is SA0142.

---

**Note:** Be sure that the port you specify as the Console Port in the OOB dialog box (see p. 28) matches the port that you connect the modem to. Change the setting, if necessary.

---

2. Set up your connection configuration as specified in Steps 2 - 8 of the *Direct Dial In Connection*, section (see page 61).
3. For Step 9, key in the SN0108 / SN0116's modem telephone number in the fields provided, then click **Next**.
4. Click **Finish**.

A new icon that you can use to connect to the SN0108 / SN0116 is created in the *Dial-up Network* folder. This completes the Indirect Dial In setup.

### **Final Check:**

To make sure that the modem and COM port are correctly installed, follow the procedures described under *Final Check* on p. 59.

### **Logging In:**

1. Double click the icon you created in the *Dial-up Network* folder.
2. Key in your Username and Password; click **Connect** and wait for the Authentication procedure to complete (be patient, it may take a few moments).
3. Use Telnet, SSH, or your browser to access the SN0108 / SN0116 the same way as if you were accessing it over the net.

---

## Telnet

---

### Logging In

1. On your computer, open a terminal (command line) session.
2. At the prompt, key in the SN0108 / SN0116's IP Address in the following way:

```
telnet [IP Address]
```

---

**Note:** The default telnet port is 23. If that port is already being used, up to 16 additional users can log in by adding a port number (from 5000 to 5015) to the login command. For example:

```
telnet [IP Address]5001
```

---

3. Press **Enter**.

The following screen appears:

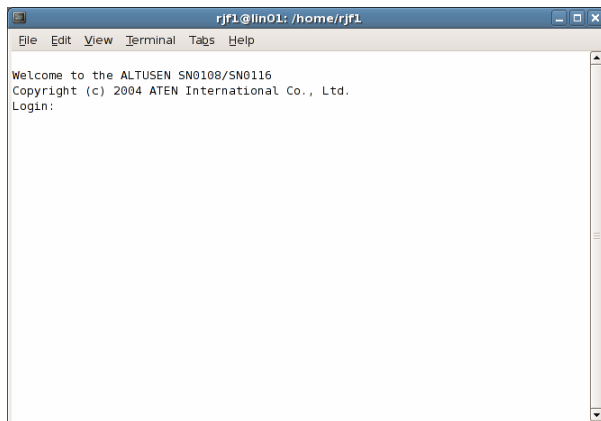

4. At the login prompt, provide your Username and Password.

---

**Note:** If you cannot see the login prompt click *Terminal/Preferences* on the telnet session's menu bar, then select *VT-100/ANSI*.

---

Once a Telnet connection to the device is established, the SN0108 / SN0116 Main Menu comes up. See p. 47 for Telnet operation.

# SSH

---

## Terminal Session (Linux):

1. Open a terminal (command line) on your computer.
2. At the prompt, key in your SN0108 / SN0116 Username and the SN0108 / SN0116's IP Address in the following way:

```
SSH [username@IP Address]
```

---

**Note:** The default SSH port is 22. If that port is already being used, up to 16 additional users can log in by adding a port number (from 5100 to 5115) to the login command. For example:

```
SSH [username@IP Address] -P 5101
```

---

3. Press **Enter**
4. When you are prompted for a password, use your SN0108 / SN0116 password.

Once an SSH connection to the device is established, the SN0108 / SN0116 Main Menu comes up:

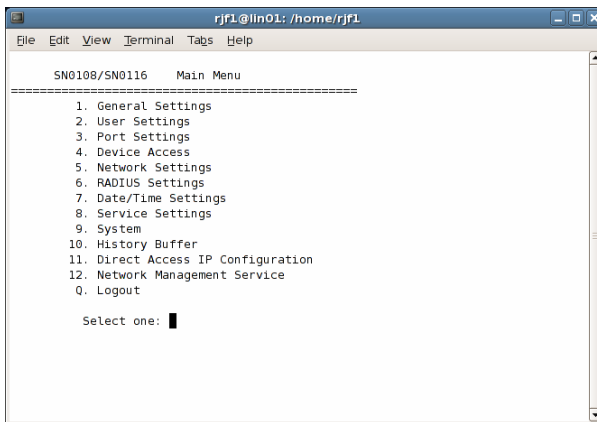
A screenshot of a terminal window titled 'rjfl@lin01: /home/rjfl'. The window displays the 'SN0108/SN0116 Main Menu' with a list of options: 1. General Settings, 2. User Settings, 3. Port Settings, 4. Device Access, 5. Network Settings, 6. RADIUS Settings, 7. Date/Time Settings, 8. Service Settings, 9. System, 10. History Buffer, 11. Direct Access IP Configuration, 12. Network Management Service, and 0. Logout. A cursor is positioned at the 'Select one:' prompt.

```
rjfl@lin01: /home/rjfl
File Edit View Terminal Tabs Help

SN0108/SN0116 Main Menu
=====
1. General Settings
2. User Settings
3. Port Settings
4. Device Access
5. Network Settings
6. RADIUS Settings
7. Date/Time Settings
8. Service Settings
9. System
10. History Buffer
11. Direct Access IP Configuration
12. Network Management Service
0. Logout

Select one: █
```

This menu is the same as the main menu that appears with Telnet sessions (see p. 47 for Telnet operation).

## **Third Party Utility (Windows):**

SSH sessions can be implemented under Windows with the use of third party utility software, such as PuTTY, a free implementation of Telnet and SSH for the Win32 and Unix platforms. To make an SSH connection with PuTTY, do the following:

1. In the *Host* Name box, enter the Internet host name of the server you want to connect to.

---

**Note:** The default SSH port is 22. If that port is already being used, select an alternate port - from 5100 to 5115. This allows up to 16 additional users to log in at the same time.

---

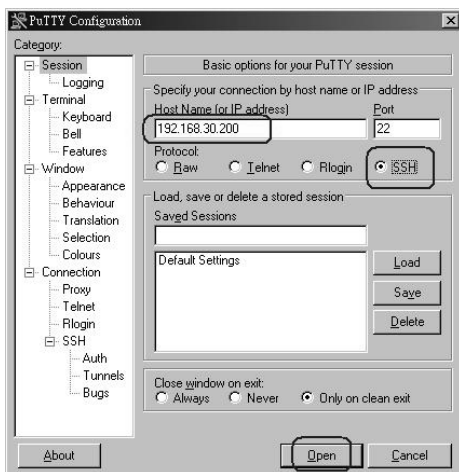

2. Select *SSH* from the Protocol buttons.
3. Click **Open** (at the bottom of the dialog box)
4. After you have connected, provide your SN0108 / SN0116 username and password at the login prompts.

---

**Note:** If you make a mistake keying in the username, the SSH protocol doesn't allow you to try again. You must close PuTTY and start over.

---

Once an SSH connection to the device is established, the SN0108 / SN0116 Main Menu comes up. This menu is the same as the main menu that appears with Telnet sessions (see p. 47 for Telnet operation).

This Page Intentionally Left Blank



# Chapter 7

## Real COM Port Management

### Overview

---

The SN0108 / SN0116 offers *Real COM Port* (Virtual COM Port) support. Devices connected to this virtual port appear as if they were connected to a COM port on the local computer. Data transmission between the device and the local computer takes place over the virtual COM port to the SN0108 / SN0116.

This mode is useful with serial devices such as POS terminals, Bar Code Readers, Serial printers, etc. In addition, this mode can be used with other Altusen management products, such as the PN9108 Power Over the NET™.

### Driver Installation

---

In order to utilize Real COM port management, the Altusen virtual COM port driver must be installed on the local computer.

### Windows 2000 and Higher Installation

To install the Windows 2000 and higher driver, do the following:

1. On the software CD that came with your SN0108 / SN0116 package, locate the file: *sn0108\_0116\_virtual COM port\_windows 2000\_vxxx.exe*

---

**Note:** The *vxxx* specified above stands for the driver's version number. The file on the CD will show an actual version number.

---

2. Double click the filename. The Setup screen appears:

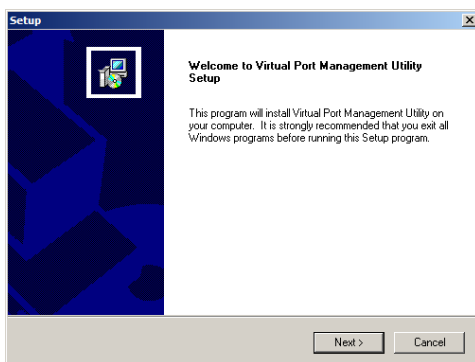

3. Click **Next** to move on.
4. Click **Yes** to accept the License Agreement.
5. Continue through the setup screens to complete the driver installation.

### **Uninstalling the Driver**

To uninstall the driver

1. Open the Windows Start menu.
2. Select: All Programs → Virtual Port Management Utility → Uninstall Manager.

### **Windows 98 Installation**

To install the Windows 98 and higher driver, do the following:

1. On the software CD that came with your SN0108 / SN0116 package, locate the file: *SN0116 Virtual Port for Win98 vxxx.exe*.

---

**Note:** The *vxxx* specified above stands for the driver's version number. The file on the CD will show an actual version number.

---

2. Double click the filename. The Setup screen appears. (It looks exactly like the screenshot, above.)
3. Click **Next** to move on.
4. Click **Yes** to accept the License Agreement.
5. Continue through the setup screens to complete the driver installation.

### **Uninstalling the Driver**

To uninstall the driver

1. Open the Windows Start menu.
2. Select: All Programs → Virtual Port Management Utility → Uninstall Manager.

## **Linux Installation**

### **Preparation**

Before installing the driver file, make sure that the target you want to map is on the network; that the port on the target you want to map is in *Real COM Port* mode; and that your Linux IP address has been specified in the SN0108 / SN0116's *Direct Access* dialog box (see *Direct Access*, page 40).

### **Installing the Driver**

To install the driver file, first become root, and do the following:

1. Create a temporary directory in your system. For example, to create a *temp* directory under root, at the # prompt use the following command:

```
mkdir /root/temp
```

---

**Note:** Under Linux, all input is case sensitive

---

2. On the software CD that came with your SN0108 / SN0116 package, locate the file *AtenVPInstall\_vxxx.tgz* (or download it from our website), and copy it into the temp directory you just created.

---

**Note:** The *vxxx* specified above stands for the driver's version number. The file on the CD will show an actual version number.

---

3. At the # prompt, uncompress *AtenVPInstall\_vxxx.tgz* with the following command:

```
tar xvfz AtenVPInstall_vxxx.tgz
```

4. After *AtenVPInstall\_vxxx.tgz* has been uncompressed, at the # prompt issue the following command:

```
./AtenVPInstall.sh
```

5. Follow the on-screen instructions to install the driver.

### **Uninstalling the Driver**

To uninstall the virtual port driver, as well as the daemon and device files, first become root, and run:

```
/usr/lib/AtenVPort/AtenVPUInstall.sh
```

This kills the daemon, and unloads the driver module from the kernel. It modifies the rc file to eliminate self-starting of the daemon and auto-loading of the module, and removes virtual port device files(/dev/ttyaxxx).

## Real COM Port Management – Windows

The Virtual Port Management Utility provides a convenient interface to COM port mapping. When you run the *Virtual Serial Port Manager* program (Start → Virtual Port Management Utility → Virtual Serial Port Manager), the following dialog box appears:

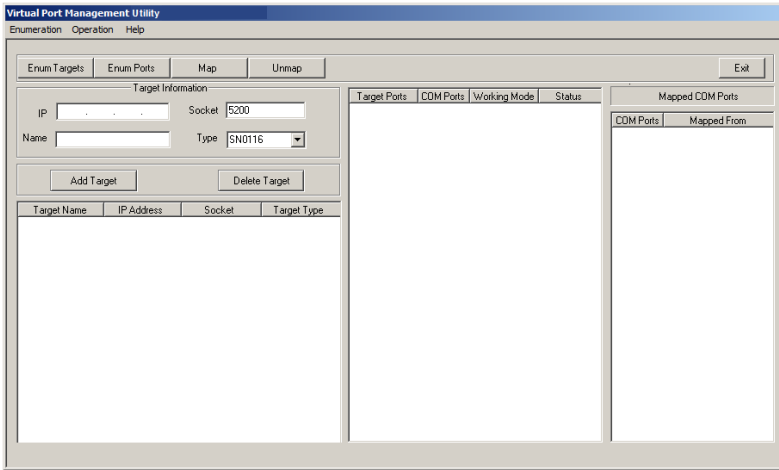

### Dialog Box Layout

The Virtual Port Management Utility dialog box is laid out as follows:

- ◆ The menu and button bars allow the automatic enumeration and listing of devices and ports.
- ◆ Below the menu and button bars, there is an area to input information in order to manually list target devices if the device doesn't appear using the automatic enumeration method.
- ◆ All target devices that were found by enumeration or manually entered are listed in the left side panel.
- ◆ All ports that were found for a selected target device are enumerated in the central panel.
- ◆ The right side panel displays the virtual COM port mappings that you have made.

## Menu and Toolbar

The Virtual Port Management Utility menu and toolbar have the same captions and functions. Users can either click the menu items or buttons to invoke the desired function, as shown in the table, below:

Item	Action
Enum Targets	This function searches and lists all SN01xx devices on the LAN. The results are shown in the Target List panel (see <i>Target List</i> , page 76, for details). Be aware that all devices listed in the Target List will be deleted when the delete function is invoked. Be sure to remove any devices from the list that you don't want to delete before invoking the delete function.
Enum Ports	This function lists the existing ports for the target device currently selected in the Target List. The results are shown in the Port List panel.
Map	After selecting a port from the <i>Port List</i> panel, selecting this function maps the device's COM port to a virtual COM port on the user's computer.
Unmap	After selecting a port from the <i>Mapped Ports</i> list, selecting this function removes the mapping between the computer and the device's COM port.

## Target Information

The Target Information fields allow a user to install (map) ports on an offline target device, as follows:

Field	Action
Target IP Address	Input the IP address of the target that you want to map COM ports to.
Base Socket Port	The base socket port of the target device.
Target Name	The name of the target. If it is different from the target's real name, it will be replaced by the real one. Note that the name is not related to the mapping or unmapping process. Only the IP address, socket port and target type are relevant.
Target Type	The type of target to be mapped. Only SN01xx series devices are valid.
Add Target	Creates an entry in the Target List based on the above information.
Delete Target	Remove the currently selected target from the Target List.

## Target List

The left side panel displays all the devices that were found with the *Enumeration* function, as well as any devices that were manually added with the *Target Information* fields.

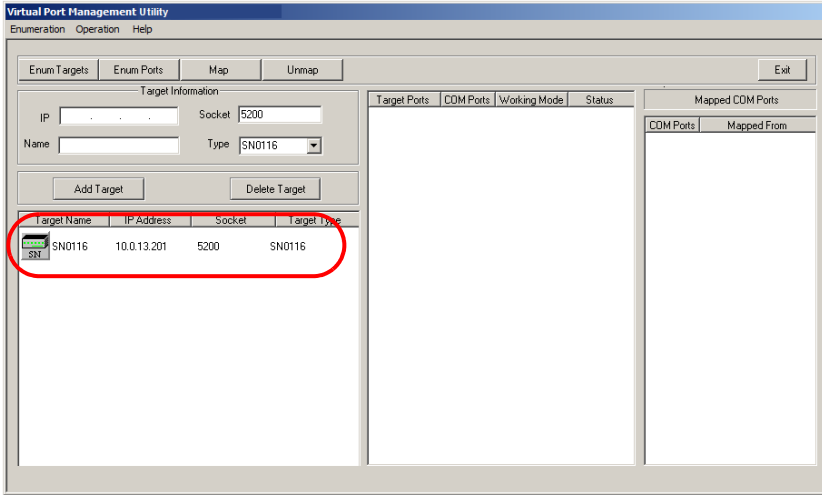

**Note:** Double clicking an item in the list invokes the same function as selecting **Enum Ports**—which displays the numbers and working modes of the selected target’s ports in the *Port List* column.

- ◆ If a device was automatically listed as a result of the *Enumeration* procedure, the icon to its left is drawn with green dots and lines to show that the target is on line and is ready to be mapped.
- ◆ If a device was added to the list manually and is off line, the icon to its left is drawn with black dots and lines. Double clicking a manually added item can get some information and display it in the *Port List*, but the working mode information is not accurate and we must assume that all the device’s ports are in Virtual Port mode. See *Operating Mode*, page 35 for details about port modes.
- ◆ If the target is off line or is on line but does not respond within 2 seconds of asking to enumerate its ports, the working mode information is not accurate and we must assume that all the device’s ports are in Virtual Port mode. See *Operating Mode*, page 35 for details about port modes.

## Port List

This list displays the port information of the selected target (only one target can be selected at a time).

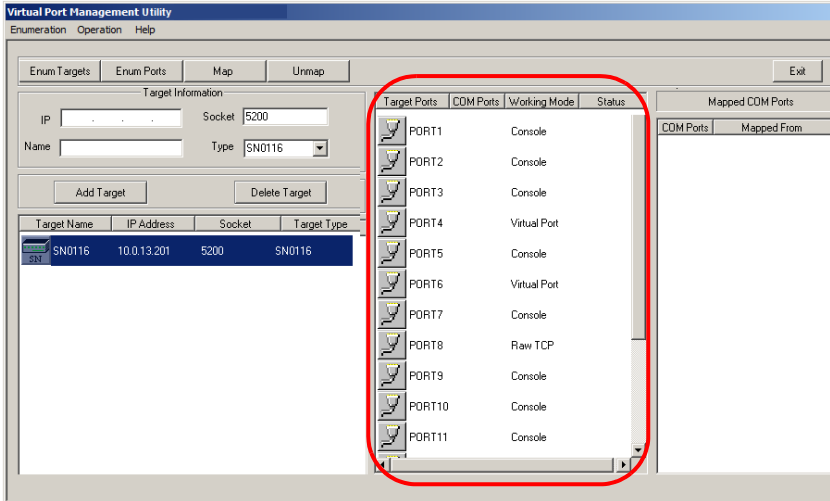

- ◆ The left column lists the target's port numbers, the second column shows the COM port it is mapped to (if any), the third column shows its working mode, and the right column shows its status.

---

**Note:** The working mode refers to the setting for the port that was specified when the port was configured. See *Port Config*, page 32, for details.

---

- ◆ Double clicking a port in the Port List brings up a *Port Mapping* dialog box that lets users select the number of COM ports they wish to map (i.e., virtual COM ports they wish to install). Only ports designated as *Virtual Port* ports can be mapped. See *Port Mapping*, page 78 for mapping details.

---

**Note:** The *Port Mapping* dialog box can also be invoked either by clicking MapTo... on the toolbar or selecting MapTo... from the menu.

---

## Mapped COM Ports

This panel displays the mapped COM ports, showing the device and port that each mapped one is derived from. The list is generated as soon as the application starts, and is dynamically updated whenever the mapped COM port configuration changes as a result of installations and removals.

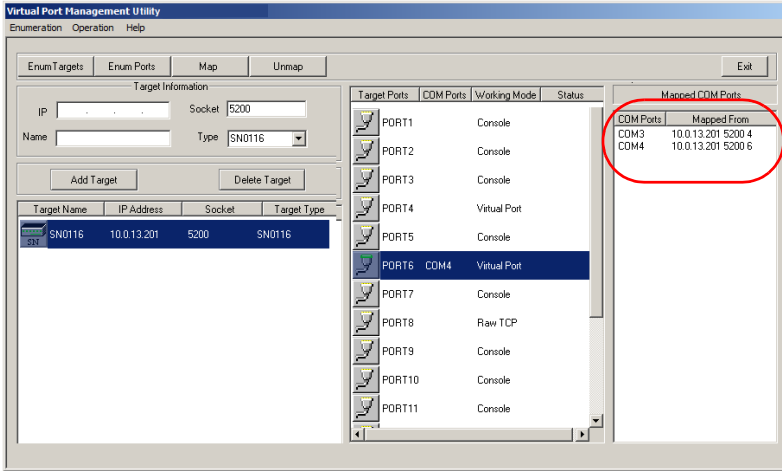

## Port Mapping and Unmapping

### Port Mapping

To map a virtual COM port:

1. Double click your Target item in the Port List to bring up the *Port Mapping* dialog box:

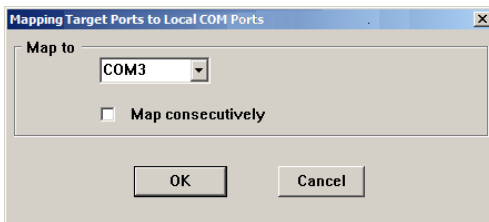

2. Drop down the list of available COM ports and select the COM port you wish to map the Target port to.



3. Click **OK** to complete the operation.

---

**Note:** 1. If a range of ports was selected, and *Map consecutively* is enabled, the COM ports are mapped to the Target ports in sequence based on the port numbers.

2. Only *Virtual Mode* ports are mapped. Other ports in the range are passed over.
- 

## Port Unmapping

To unmap virtual COM ports:

1. Either click **Unmap...** on the button bar or select *Unmap...* from the menu to bring up the *Port Unmapping* dialog box:

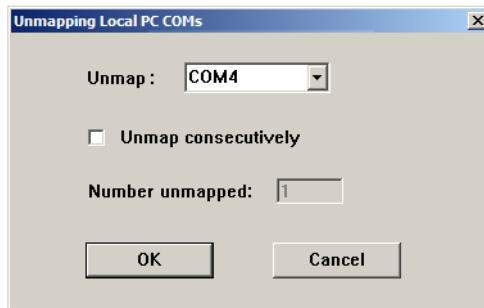

2. Drop down the list of mapped COM ports and select the COM port you wish to unmap.
3. Click **OK** to complete the operation.

---

**Note:** For a consecutive unmapping, the COM ports are unmapped in sequence based on the mapped COM port number.

---

## **Real COM Port Management – Linux**

---

### **Mapping/Unmapping Virtual Ports**

To map or unmap virtual ports, do the following:

1. As root, go to the /usr/lib/AtenVPort directory.
2. Issue the following command:

```
/AtenVPMapping
```

The process can run in either *Interactive* mode or *Fast* mode. With Interactive mode, users don't specify any parameters on the command line. They make mapping/unmapping choices based on questions generated as the program runs.

With Fast mode, users specify parameters on the command line to indicate their mapping/unmapping choices – as shown in the following examples:

1. Mapping (input should all be on one line):  
./AtenVPMapping map(1) PCPort(0-255) TargetIP(a.b.c.d)  
TargetPort(1-48) NumberofMapping(1-48)
2. Unmapping (input should all be on one line):  
./AtenVPMapping unmap(0) PCPort(0-255) NumberofUnMapping(1-48)

### **Virtual Port Naming Rules**

All of the ATEN SN virtual ports under Linux have the prefix *ttya*.

Mapped virtual ports can be found in the /dev dir. They all have a prefix of *ttya* (ttya000, ttya001, etc.). The range is from ttya000 – ttya255.

## Safety Instructions

---

### General

- ◆ Read all of these instructions. Save them for future reference.
- ◆ Follow all warnings and instructions marked on the device.
- ◆ Do not place the device on any unstable surface (cart, stand, table, etc.). If the device falls, serious damage will result.
- ◆ Do not use the device near water.
- ◆ Do not place the device near, or over, radiators or heat registers.
- ◆ The device cabinet is provided with slots and openings to allow for adequate ventilation. To ensure reliable operation, and to protect against overheating, these openings must never be blocked or covered.
- ◆ The device should never be placed on a soft surface (bed, sofa, rug, etc.) as this will block its ventilation openings. Likewise, the device should not be placed in a built in enclosure unless adequate ventilation has been provided.
- ◆ Never spill liquid of any kind on the device.
- ◆ Unplug the device from the wall outlet before cleaning. Do not use liquid or aerosol cleaners. Use a damp cloth for cleaning.
- ◆ The device should be operated from the type of power source indicated on the marking label. If you are not sure of the type of power available, consult your dealer or local power company.
- ◆ The device is designed for IT power distribution systems with 230V phase-to-phase voltage.
- ◆ The device is equipped with a 3-wire grounding type plug. This is a safety feature. If you are unable to insert the plug into the outlet, contact your electrician to replace your obsolete outlet. Do not attempt to defeat the purpose of the grounding-type plug. Always follow your local/national wiring codes.
- ◆ Do not allow anything to rest on the power cord or cables. Route the power cord and cables so that they cannot be stepped on or tripped over.
- ◆ If an extension cord is used with this device make sure that the total of the ampere ratings of all products used on this cord does not exceed the extension cord ampere rating. Make sure that the total of all products plugged into the wall outlet does not exceed 15 amperes.

- ◆ To help protect your system from sudden, transient increases and decreases in electrical power, use a surge suppressor, line conditioner, or uninterruptible power supply (UPS).
- ◆ Position system cables and power cables carefully; Be sure that nothing rests on any cables.
- ◆ Never push objects of any kind into or through cabinet slots. They may touch dangerous voltage points or short out parts resulting in a risk of fire or electrical shock.
- ◆ Do not attempt to service the device yourself. Refer all servicing to qualified service personnel.
- ◆ If the following conditions occur, unplug the device from the wall outlet and bring it to qualified service personnel for repair.
  - ◆ The power cord or plug has become damaged or frayed.
  - ◆ Liquid has been spilled into the device.
  - ◆ The device has been exposed to rain or water.
  - ◆ The device has been dropped, or the cabinet has been damaged.
  - ◆ The device exhibits a distinct change in performance, indicating a need for service.
  - ◆ The device does not operate normally when the operating instructions are followed.
- ◆ Only adjust those controls that are covered in the operating instructions. Improper adjustment of other controls may result in damage that will require extensive work by a qualified technician to repair.
- ◆ Do not connect the RJ-11 connector marked “UPGRADE” to a public telecommunication network.

---

## **DC Power**

- ◆ The system relies on the protective devices in the building installation for protection against short-circuit, overcurrent, and earth (grounding) fault. Ensure that the protective devices in the building installation are properly rated to protect the system, and that they comply with national and local codes.
- ◆ Ensure that there is a readily accessible disconnect device incorporated in the building's installation wiring.
- ◆ A separate protective earthing terminal is provided on this product and shall be permanently connected to earth.
- ◆ For the DC supply circuit, select a DC supply cable that is certified by UL, AWM VW-1 Style 1015, minimum 16 AWG, minimum 105° C, minimum 300 V.
- ◆  **CAUTION:** This equipment is designed to permit the connection of the earthed conductor of the DC supply circuit to the earthing conductor at the equipment. If this connection is made, all of the following conditions must be met:
  - ◆ This equipment shall be connected directly to the DC supply system earthing electrode conductor or to a bonding jumper from an earthing terminal bar or bus to which the DC supply system earthing electrode conductor is connected.
  - ◆ This equipment shall be located in the same immediate area (such as adjacent cabinets) as any other equipment that has a connection between the earthed conductor of the same DC supply circuit and the earthing conductor, and also the point of earthing of the DC system. The DC system shall not be earthed elsewhere.
  - ◆ The DC supply source is to be located within the same premises as this equipment.
  - ◆ Switching or disconnecting devices shall not be in the earthed circuit conductor between the DC source and the point of connection of the earthing electrode conductor.
- ◆ **WARNING:** This unit is intended for installation in restricted access areas. A restricted access area (server room, data center, etc.) is where access can only be gained by service personnel through the use of a special tool, lock and key, or other means of security, and is controlled by the authority responsible for the location.

## **Rack Mounting**

- ◆ Before working on the rack, make sure that the stabilizers are secured to the rack, extended to the floor, and that the full weight of the rack rests on the floor. Install front and side stabilizers on a single rack or front stabilizers for joined multiple racks before working on the rack.
- ◆ Always load the rack from the bottom up, and load the heaviest item in the rack first.
- ◆ Make sure that the rack is level and stable before extending a device from the rack.
- ◆ Use caution when pressing the device rail release latches and sliding a device into or out of a rack; the slide rails can pinch your fingers.
- ◆ After a device is inserted into the rack, carefully extend the rail into a locking position, and then slide the device into the rack.
- ◆ Do not overload the AC supply branch circuit that provides power to the rack. The total rack load should not exceed 80 percent of the branch circuit rating.
- ◆ Make sure that all equipment used on the rack – including power strips and other electrical connectors – is properly grounded.
- ◆ Ensure that proper airflow is provided to devices in the rack.
- ◆ Ensure that the operating ambient temperature of the rack environment does not exceed the maximum ambient temperature specified for the equipment by the manufacturer
- ◆ Do not step on or stand on any device when servicing other devices in a rack.

---

## Consignes de sécurité

---

### Général

- ◆ Ce produit est destiné exclusivement à une utilisation à l'intérieur.
- ◆ Veuillez lire la totalité de ces instructions. Conservez-les afin de pouvoir vous y référer ultérieurement.
- ◆ Respectez l'ensemble des avertissements et instructions inscrits sur l'appareil.
- ◆ Ne placez jamais l'unité sur une surface instable (chariot, pied, table, etc.). Si l'unité venait à tomber, elle serait gravement endommagée.
- ◆ N'utilisez pas l'unité à proximité de l'eau.
- ◆ Ne placez pas l'unité à proximité de ou sur des radiateurs ou bouches de chaleur.
- ◆ Le boîtier de l'unité est doté de fentes et d'ouvertures destinées à assurer une ventilation adéquate. Pour garantir un fonctionnement fiable et protéger l'unité contre les surchauffes, ces ouvertures ne doivent jamais être bloquées ou couvertes.
- ◆ L'unité ne doit jamais être placée sur une surface molle (lit, canapé, tapis, etc.) car ses ouvertures de ventilation se trouveraient bloquées. De même, l'unité ne doit pas être placée dans un meuble fermé à moins qu'une ventilation adaptée ne soit assurée.
- ◆ Ne renversez jamais de liquides de quelque sorte que ce soit sur l'unité.
- ◆ Débranchez l'unité de la prise murale avant de la nettoyer. N'utilisez pas de produits de nettoyage liquide ou sous forme d'aérosol. Utilisez un chiffon humide pour le nettoyage de l'unité.
- ◆ L'appareil doit être alimenté par le type de source indiqué sur l'étiquette. Si vous n'êtes pas sûr du type d'alimentation disponible, consultez votre revendeur ou le fournisseur local d'électricité.
- ◆ Afin de ne pas endommager votre installation, vérifiez que tous les périphériques sont correctement mis à la terre.
- ◆ L'unité est équipée d'une fiche de terre à trois fils. Il s'agit d'une fonction de sécurité. Si vous ne parvenez pas à insérer la fiche dans la prise murale, contactez votre électricité afin qu'il remplace cette dernière qui doit être obsolète. N'essayez pas d'aller à l'encontre de l'objectif de la fiche de terre. Respectez toujours les codes de câblage en vigueur dans votre région/pays.

- ♦ L'équipement doit être installé à proximité de la prise murale et le dispositif de déconnexion (prise de courant femelle) doit être facile d'accès.
- ♦ La prise murale doit être installée à proximité de l'équipement et doit être facile d'accès.
- ♦ Veillez à ce que rien ne repose sur le cordon d'alimentation ou les câbles. Acheminez le cordon d'alimentation et les câbles de sorte que personne ne puisse marcher ou trébucher dessus.
- ♦ En cas d'utilisation d'une rallonge avec cette unité, assurez-vous que le total des ampérages de tous les produits utilisés sur cette rallonge ne dépasse pas l'ampérage nominal de cette dernière. Assurez-vous que le total des ampérages de tous les produits branchés sur la prise murale ne dépasse pas 15 ampères.
- ♦ Pour contribuer à protéger votre système contre les augmentations et diminutions soudaines et transitoires de puissance électrique, utilisez un parasurtenseur, un filtre de ligne ou un système d'alimentation sans coupure (UPS).
- ♦ Placez les câbles du système et les câbles d'alimentation avec précaution ; veillez à ce que rien ne repose sur aucun des câbles.
- ♦ Lors du branchement ou du débranchement à des blocs d'alimentation permettant la connexion à chaud, veuillez respecter les lignes directrices suivantes:
- ♦ Installez le bloc d'alimentation avant de brancher le câble d'alimentation à celui-ci.
- ♦ Débranchez le câble d'alimentation avant de retirer le bloc d'alimentation.
- ♦ Si le système présente plusieurs sources d'alimentation, déconnectez le système de l'alimentation en débranchant tous les câbles d'alimentation des blocs d'alimentation.
- ♦ N'insérez jamais d'objets de quelque sorte que ce soit dans ou à travers les fentes du boîtier. Ils pourraient entrer en contact avec des points de tension dangereuse ou court-circuiter des pièces, entraînant ainsi un risque d'incendie ou de choc électrique.
- ♦ N'essayez pas de réparer l'unité vous-même. Confiez toute opération de réparation à du personnel qualifié.
- ♦ Si les conditions suivantes se produisent, débranchez l'unité de la prise murale et amenez-la à un technicien qualifié pour la faire réparer:
  - ♦ Le cordon d'alimentation ou la fiche ont été endommagés ou éraillés.
  - ♦ Du liquide a été renversé dans l'unité.



- ◆ L'unité a été exposée à la pluie ou à l'eau.
- ◆ L'unité est tombée ou le boîtier a été endommagé.
- ◆ Les performances de l'unité sont visiblement altérées, ce qui indique la nécessité d'une réparation.
- ◆ L'unité ne fonctionne pas normalement bien que les instructions d'utilisation soient respectées.
- ◆ N'utilisez que les commandes qui sont abordées dans le mode d'emploi. Le réglage incorrect d'autres commandes peut être à l'origine de dommages qui nécessiteront beaucoup de travail pour qu'un technicien qualifié puisse réparer l'unité.
- ◆ Ne connectez pas le connecteur RJ-11 portant la marque « Sensor » (Capteur) à un réseau de télécommunication public.

## **Montage sur bâti**

- ♦ Avant de travailler sur le bâti, assurez-vous que les stabilisateurs sont bien fixés sur le bâti, qu'ils sont étendus au sol et que tout le poids du bâti repose sur le sol. Installez les stabilisateurs avant et latéraux sur un même bâti ou bien les stabilisateurs avant si plusieurs bâtis sont réunis, avant de travailler sur le bâti.
- ♦ Chargez toujours le bâti de bas en haut et chargez l'élément le plus lourd en premier.
- ♦ Assurez-vous que le bâti est à niveau et qu'il est stable avant de sortir une unité du bâti.
- ♦ Agissez avec précaution lorsque vous appuyez sur les loquets de libération du rail d'unité et lorsque vous faites coulisser une unité dans et hors d'un bâti ; vous pourriez vous pincer les doigts dans les rails.
- ♦ Une fois qu'une unité a été insérée dans le bâti, étendez avec précaution le rail dans une position de verrouillage puis faites glisser l'unité dans le bâti.
- ♦ Ne surchargez pas le circuit de l'alimentation CA qui alimente le bâti. La charge totale du bâti ne doit pas dépasser 80 % de la capacité du circuit.
- ♦ Assurez-vous que tous les équipements utilisés sur le bâti, y-compris les multiprises et autres connecteurs électriques, sont correctement mis à la terre.
- ♦ Assurez-vous que les unités présentes dans le bâti bénéficie d'une circulation d'air suffisante.
- ♦ Assurez-vous que la température ambiante de fonctionnement de l'environnement du bâti ne dépasse pas la température ambiante maximale spécifiée pour l'équipement par le fabricant.
- ♦ Ne marchez sur aucun appareil lors de la maintenance d'autres appareils d'un bâti.

## Technical Support

---

### International

- ◆ For online technical support – including troubleshooting, documentation, and software updates: **<http://support.aten.com>**
- ◆ For telephone support, see *Telephone Support*, page iii

### North America

Email Support		<a href="mailto:support@aten-usa.com">support@aten-usa.com</a>
Online Technical Support	Troubleshooting Documentation Software Updates	<a href="http://www.aten-usa.com/support">http://www.aten-usa.com/support</a>
Telephone Support		1-888-999-ATEN ext 4988

When you contact us, please have the following information ready beforehand:

- ◆ Product model number, serial number, and date of purchase.
- ◆ Your computer configuration, including operating system, revision level, expansion cards, and software.
- ◆ Any error messages displayed at the time the error occurred.
- ◆ The sequence of operations that led up to the error.
- ◆ Any other information you feel may be of help.

## Specifications

### SN0108 / SN0116

Function		SN0108	SN0116
Serial Connectors	To Devices	8 x Serial Device Jacks	16 x Serial Device Jacks
	To LAN	1 x RJ-45	
Power Connector		1 x 3-prong AC Socket	
LEDs	Link [LAN]	1 x Green	
	10/100 Mbps	1 x Orange/Green	
	Power	1 x Blue	
	RS-232 Port	8 x Green	16 x Green
Switches	Power	1 x Rocker	
	Reset	1 x Semi-recessed pushbutton	
I/P Rating		100–240VAC; 50/60Hz; 1A	
Power Consumption		120V; 8W / 230V; 8W	
Environment	Operating Temp.	0–40° C	
	Storage Temp.	-20–60° C	
	Humidity	0–80% RH	
Physical Properties	Housing	Metal	
	Weight	3.3 kg	3.4 kg
	Dimensions L x W x H	43.72 x 21.4 x 44 cm	

**SN0108D / SN0116D**

Function		SN0108	SN0116
Serial Connectors	To Devices	8 x Serial Device Jacks	16 x Serial Device Jacks
	To LAN	1 x RJ-45	
Power Connector		DC Terminal	
LEDs	Link [LAN]	1 x Green	
	10/100 Mbps	1 x Orange/Green	
	Power	1 x Blue	
	RS-232 Port	8 x Green	16 x Green
Switches	Power	1 x Rocker	
	Reset	1 x Semi-recessed pushbutton	
I/P Rating		36–75V DC; 2A	
Power Consumption		8W	
Environment	Operating Temp.	0–40° C	
	Storage Temp.	-20–60° C	
	Humidity	0–80% RH	
Physical Properties	Housing	Metal	
	Weight	3.3 kg	3.4 kg
	Dimensions L x W x H	43.72 x 21.4 x 44 cm	

## Administrator Login Failure

If you are unable to perform an Administrator login (because the Username and Password information has become corrupted, or you have forgotten it, for example), you can clear the login information with the following procedure:

1. Power off the SN0108 / SN0116 and remove its housing.
2. Short the jumper labeled J6.

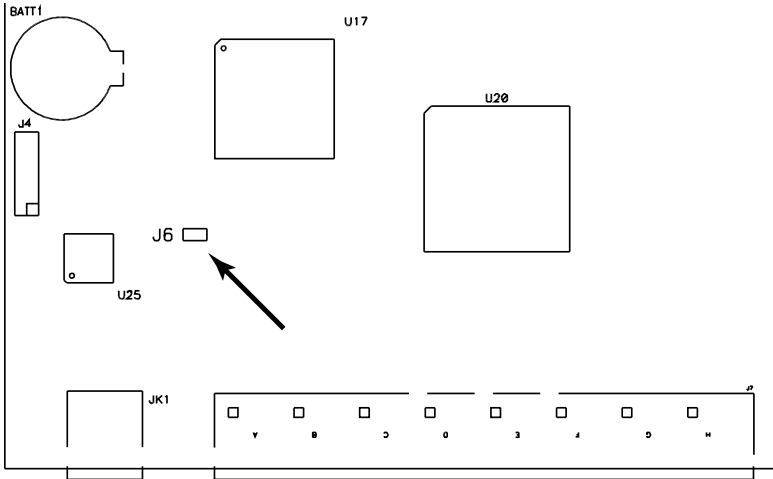

3. Power on the switch.
4. When the Link and 10/100Mbps LEDs flash, power off the switch.
5. Remove the jumper cap from J6.
6. Close the housing and start the SN0108 / SN0116 back up.  
After you start back up, you can use the default Username and Password (see *Logging In*, page 19) to log in.

---

## IP Address Determination

---

The SN0108 / SN0116's default setting is to obtain its IP address automatically from a DHCP server. When the SN0108 / SN0116 starts, it waits to get an address from a DHCP server. If, after one minute, it fails to obtain an address from the DHCP server, it reverts to its default IP address of 192.168.0.60.

If you are an administrator and need to determine the SN0108 / SN0116's IP address, or want to assign it one, there are three methods to choose from. In each case, your computer must be on the same network segment as the SN0108 / SN0116.

### Method 1:

For computers running Windows, an IP address can be determined and/or assigned with the IP Installer utility:

1. Open the IPInstaller directory on the Software CD that came with your PN9108 package and run IPInstaller.exe. A dialog box similar to the one below appears:

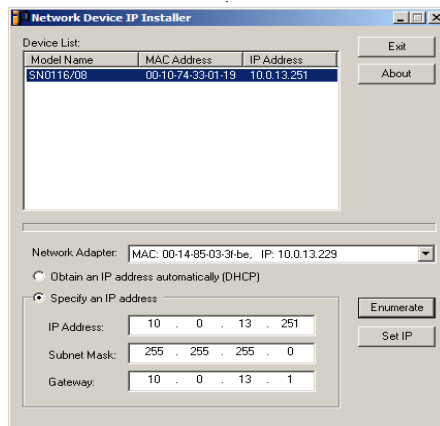

2. Select the SN0108 / SN0116 in the *Device List*.

---

**Note:** 1. If the list is empty, or your device doesn't appear, click **Enumerate** to refresh the Device List.

2. If there is more than one device in the list, use the MAC address to pick the one you want. The SN0108 / SN0116's MAC address is located on its bottom panel.
-

3. Select either *Obtain an IP address automatically (DHCP)*, or *Specify an IP address*. If you chose the latter, fill the IP Address, Subnet Mask, and Gateway fields with the information appropriate to your network.
4. Click **Set IP**.
5. After the IP address shows up in the Device List, click **Exit** to end the program.

**Method 2:**

1. Set your computer's IP address to 192.168.0.XXX  
Where XXX represents any number or numbers except 60. (192.168.0.60 is the default address of the SN0108 / SN0116.)
2. Specify the switch's default IP address (192.168.0.60) in your browser, and you will be able to connect.
3. Assign a fixed IP address for the SN0108 / SN0116 that is suitable for the network segment that it resides on.
4. After you log out, reset your computer's IP address to its original value.

**Method 3:**

A fixed IP address can also be assigned with the ARP command as follows:

1. Turn off the power to the SN0108 / SN0116.
2. Enter the following command:

```
arp -s <ip address> <SN0108 / SN0116's MAC address>
```

Where the IP address that you assign is one suitable for the network segment that the SN0108 / SN0116 resides on.

---

**Note:** The MAC address can be found on the bottom panel.

---

3. Turn the power to the SN0108 / SN0116 back on.
4. In your browser, go to the IP address you just assigned and log in with your Username and Password.

---

**Note:** You must log in within 30 seconds after entering the arp command. Therefore, it would be advisable to have your browser all set up to go to the IP address beforehand.

---

5. Once you have logged in, go to *Network*, to set up the permanent IP environment (see page 23).



## Self-Signed Private Certificates

---

If you wish to create your own self-signed encryption key and certificate, a free utility – `openssl.exe` – is available for download over the web at [www.openssl.org](http://www.openssl.org). To create your private key and certificate do the following:

1. Go to the directory where you downloaded and extracted `openssl.exe` to.
2. Run `openssl.exe` with the following parameters:

```
openssl req -new -newkey rsa:1024 -days 3653 -nodes -x509
-keyout CA.key -out CA.cer -config openssl.cnf
```

---

**Note:** 1. The command should be entered all on one line (i.e., do not press [Enter] until all the parameters have been keyed in).

2. If there are spaces in the input, surround the entry in quotes (e.g., “ATEN International”).
- 

To avoid having to input information during key generation the following additional parameters can be used:

```
/C /ST /L /O /OU /CN /emailAddress.
```

### Examples

```
openssl req -new -newkey rsa:1024 -days 3653 -nodes -x509
-keyout CA.key -out CA.cer -config openssl.cnf -subj
/C=yourcountry/ST=yourstateorprovince/L=yourlocationor
city/O=yourorganization/OU=yourorganizationalunit/
CN=yourcommonname/emailAddress=name@yourcompany.com
```

```
openssl req -new -newkey rsa:1024 -days 3653 -nodes -x509
-keyout CA.key -out CA.cer -config openssl.cnf -subj
/C=CA/ST=BC/L=Richmond/O="ATEN International"/OU=ATEN
/CN=ATEN/emailAddress=eservice@aten.com.tw
```

### Importing the Files

After the `openssl.exe` program completes, two files – `CA.key` (the private key) and `CA.cer` (the self-signed SSL certificate) – are created in the directory that you ran the program from. These are the files that you upload in the *Private Certificate* panel of the Security page (see page 31).

## RJ-45 to Serial Adapters

RJ-45 to Serial adapters are not included with the SN0108 / SN0116 package. To purchase these adapters, contact your dealer. The tables on the following pages describe the available adapter configurations.

### SA0141: RJ45-F to DB9-F (Black Connector)

DTE to DTE

SN0108 / SN0116 (RJ45)	Pins (8)		Computer (DB9)
RTS	1	<—————>	8
DTR	2	<—————>	6+1
TXD	3	<—————>	2
CTS	4	<—————>	7
GND	5	<—————>	5
RXD	6	<—————>	3
DSR	7&8	<—————>	4
			9 NC not used

### SA0142: RJ45-F to DB9-M (Black Connector)

DTE to DCE

SN0108 / SN0116 (RJ45)	Pins (8)		Modem/Device (DB9)
RTS	1	<—————>	7
DTR	2	<—————>	4
TXD	3	<—————>	3
CTS	4	<—————>	8
GND	5	<—————>	5
RXD	6	<—————>	2
DCD	7	<—————>	1
DSR	8	<—————>	6
			9 NC not used

**SA0143:** RJ45-F to DB25-F (Black Connector)

DTE to DTE

SN0108 / SN0116 (RJ45)	Pins (8)		Computer (DB25)
RTS	1	←————→	5
DTR	2	←————→	6+8
TXD	3	←————→	3
CTS	4	←————→	4
GND	5	←————→	7
RXD	6	←————→	2
DSR	7&8	←————→	20
Other pins not used			

**SA0144:** RJ45-F to DB25-M (Black Connector)

DTE to DCE

SN0108 / SN0116 (RJ45)	Pins (8)		Modem/Device (DB25)
RTS	1	←————→	4
DTR	2	←————→	20
TXD	3	←————→	2
CTS	4	←————→	5
GND	5	←————→	7
RXD	6	←————→	3
DCD	7	←————→	8
DSR	8	←————→	6
Other pins not used			

**SA0145:** RJ45-F to DB9-M (Blue Connector)

DTE to DTE

SN0108 / SN0116 (RJ45)	Pins (8)		Computer (DB9)
RTS	1	<—————>	8
DTR	2	<—————>	6&1
TXD	3	<—————>	2
CTS	4	<—————>	7
GND	5	<—————>	5
RXD	6	<—————>	3
DSR	7&8	<—————>	4
9 NC not used			

**SA0146:** RJ45-F to DB9-F (Blue Connector)

DTE to DCE

SN0108 / SN0116 (RJ45)	Pins (8)		Modem/Device (DB9)
RTS	1	<—————>	7
DTR	2	<—————>	4
TXD	3	<—————>	3
CTS	4	<—————>	8
GND	5	<—————>	5
RXD	6	<—————>	2
DCD	7	<—————>	1
DSR	8	<—————>	6
9 NC not used			

**SA0147:** RJ45-F to DB25-M (Blue Connector)

DTE to DTE

SN0108 / SN0116 (RJ45)	Pins (8)		Computer (DB25)
RTS	1	←————→	5
DTR	2	←————→	6+8
TXD	3	←————→	3
CTS	4	←————→	4
GND	5	←————→	7
RXD	6	←————→	2
DSR	7&8	←————→	20
Other pins not used			

**SA0148:** RJ45-F to DB25-F (Blue Connector)

DTE to DCE

SN0108 / SN0116 (RJ45)	Pins (8)		Modem/Device (DB25)
RTS	1	←————→	4
DTR	2	←————→	20
TXD	3	←————→	2
CTS	4	←————→	5
GND	5	←————→	7
RXD	6	←————→	3
DCD	7	←————→	8
DSR	8	←————→	6
Other pins not used			

## Troubleshooting

---

Operation problems can be due to a variety of causes. The first step in solving them is to make sure that all cables are securely attached and seated completely in their sockets.

In addition, updating the product's firmware may solve problems that have been discovered and resolved since the prior version was released. If your product is not running the latest firmware version, we strongly recommend that you upgrade. See <x reference to Firmware Upgrade Chapter or Section>, for upgrade details.

Problem	Solution
After I shut the SN0108 / SN0116 off and then turn it back on, the Time and Date Settings are lost.	The SN0108 / SN0116's battery needs to be replaced. Open the housing and replace the battery.

## Battery Replacement

---

This equipment is provided with a replaceable lithium battery: CR2032 3V. Replacement by an incorrect type may result in an explosion.

**CAUTION!**

RISK OF EXPLOSION IF BATTERY IS REPLACED BY AN  
INCORRECT TYPE.

DISPOSE OF USED BATTERIES ACCORDING TO THE  
INSTRUCTIONS.

---

## Limited Warranty

---

ALTUSEN warrants this product against defects in material or workmanship for a period of one (1) year from the date of purchase. If this product proves to be defective, contact ALTUSEN's support department for repair or replacement of your unit. ALTUSEN will not issue a refund. Return requests can not be processed without the original proof of purchase.

When returning the product, you must ship the product in its original packaging or packaging that gives an equal degree of protection. Include your proof of purchase in the packaging and the RMA number clearly marked on the outside of the package.

This warranty becomes invalid if the factory-supplied serial number has been removed or altered on the product.

This warranty does not cover cosmetic damage or damage due to acts of God, accident, misuse, abuse, negligence or modification of any part of the product. This warranty does not cover damage due to improper operation or maintenance, connection to improper equipment, or attempted repair by anyone other than ALTUSEN. This warranty does not cover products sold AS IS or WITH FAULTS.

IN NO EVENT SHALL ALTUSEN'S LIABILITY EXCEED THE PRICE PAID FOR THE PRODUCT. FURTHER, ALTUSEN SHALL NOT BE RESPONSIBLE FOR DIRECT, INDIRECT, SPECIAL, INCIDENTAL OR CONSEQUENTIAL DAMAGES RESULTING FROM THE USE OF THE PRODUCT, ITS ACCOMPANYING SOFTWARE, OR ITS DOCUMENTATION. ALTUSEN SHALL NOT IN ANY WAY BE RESPONSIBLE FOR, WITHOUT LIMITATION, LOSS OF DATA, LOSS OF PROFITS, DOWNTIME, GOODWILL, DAMAGE OR REPLACEMENT OF EQUIPMENT OR PROPERTY, AND ANY EXPENSES FROM RECOVERY, PROGRAMMING, AND REPRODUCTION OF ANY PROGRAM OR DATA.

ALTUSEN makes no warranty or representation, expressed, implied, or statutory with respect to its products, contents or use of this documentation and all accompanying software, and specifically disclaims its quality, performance, merchantability, or fitness for any particular purpose.

ALTUSEN reserves the right to revise or update its product, software or documentation without obligation to notify any individual or entity of such revisions, or update.

For details about extended warranties, please contact one of our dedicated value added resellers.

This Page Intentionally Left Blank



# Index

## A

- Administration, 21
  - ANMS settings, 25
  - Date and time, 29
  - Firmware upgrade, 30
  - General settings, 21
  - Network settings, 23
- Administrator Login Failure, 92
- Administrator password, 22
- Alert settings, 36
- ANMS
  - Radius Settings, 26
  - SNMP Settings, 27
- ANMS settings, 25

## B

- Battery Replacement, 100
- Browser
  - Main screen, 20
- Browser log in, 19
- Browser operation
  - Overview, 45
  - Telnet, 47

## C

- Components
  - Front panel, 5
  - Rear panel, 6, 7
- Configuration
  - device management, 32
- Connection Control, 22
- Console Management, 35
- Corrupt Password, 92

## D

- Date and time, 29

- Device management configuration, 32
- Direct Access, 40

## F

- Firmware upgrade, 30
- Forgotten Password, 92

## G

- General settings, 21

## H

- HyperTerminal
  - direct connection, 53
  - indirect connection, 58

## I

- Installation
  - PC, 11, 13
  - PC SN0108 / SN0116, 11
  - PC SN0108D / SN0116D, 13
  - Sun SN0108 / SN0116, 15
  - Sun SN0108D / SN0116D, 17
  - Sunfire V100, 15, 17
- IP Address, 24
- IP address determination, 93

## L

- Linux
  - Real COM Port
    - Driver Installation, 73
  - Virtual COM Port
    - Driver Installation, 73
- Log, 43
- Logging in
  - browser, 19
- Logging Out, 20

**M**

Mounting, 10

**N**

Network

IP Address, 24

Service Ports, 23

Network settings, 23

**O**

Online

Registration, iii

OOB Operation

direct HyperTerminal, 53

direct PPP, 61

indirect HyperTerminal, 58

indirect PPP, 65

OOBC, 28

Operating Mode, 35

Out of band configuration, 28

Out of Band Operation, 53

Overview, 1

**P**

Port alert configuration, 36

Port configuration, 32

Property settings, 33

serial settings, 33

Port Mapping, 78

Port Unmapping, 79

PPP

direct connection, 61

indirect connection, 65

Private Certificates, 95

Property settings, 33

PuTTY, 69

**R**

Rack Mounting, 10

Safety information, 83

Radius Settings, 26

Real COM Port

Driver Installation

Linux, 73

Real COM Port Driver Installation

Windows, 71

Real COM Port Management, 71

Linux, 80

Windows, 74

Real COM Port. See Virtual COM Port

RJ-45 to Serial Adapters, 96

RoHS, ii

**S**

Safety Instructions

DC Power, 83

General, 81

Rack Mounting, 84

Self-signed certificates, 95

Serial port settings, 33

Service Ports, 23

Session Info, 41

SJ/T 11364-2006, ii

SN0108 / SN0116

Rear panel, 6

SN0108D / SN0116D

Rear panel, 7

SN0116

Rear panel, 6, 7

SNMP Settings, 27

Specifications, 90

SSH

terminal (Linux) session, 68

third party utility (Windows), 69

Stacking, 9

Sunfire V100 installation, 15, 17

System Information, 42

**T**

Technical Support, 89  
Telephone support, iii  
Telnet, 47, 67  
Troubleshooting, 100

**U**

User Accounts  
  adding, 38  
  deleting, 38  
  editing, 39  
User Manager, 37  
User Notice, iii

**V**

Virtual COM Port

Driver Installation

  Linux, 73

  Setting, 35

Virtual COM Port Driver Installation

  Windows, 71

Virtual COM Port Management, 71

Virtual Port Management

  Dialog box layout, 74

  Port Mapping and  
  Unmapping, 78

Virtual Port Utility

  Menu and toolbar, 75

  Port List, 77

  Port Mapping, 78

  Port Unmapping, 79

  Target information, 75

  Target list, 76